

PRODUCT SPECIFICATION

22 Series Relays



Technical data	22/1
Specifications	22/2
Model Number Structure	22/3
Model Number Selection and Dimensions	22/4
Internal Connections	22/5
Electrical Characteristics	22/5
Accessories	22/6
Protection & Safety Precautions	22/7 - 22/8

Relays

Features:

- Compact housing only 12.7mm wide
- Non-polarized LED indicator
- Excellent electrical and mechanical life
- Provided with nameplate
- Environmental friendly, RoHS directive compliant
- Diode type:
Diode reverse withstand voltage: 1000V
- High switching power (1-pole: 12 A)



Approvals

Approbations and Declaration of conformity

CE

CE

Overvoltage category

III, as per EN IEC 60947-5-1

AC Coil Ratings

Voltage (V)	Rated Current (mA)		Coil Resistance (Ω)	Coil Inductance (H) (reference value)		Operation Properties		
	AC 50Hz	AC 60Hz		Arm. OFF	Arm. ON	Released Voltage	Continuous Voltage	Operate Voltage
12V	87.8	75	62.5	0.17	0.38	30% min.	110% max	80% min.
24V	43.7	37.6	253	0.81	1.55			
110V	9.6	8.2	5566	13.33	26.83			
230V	4.4	3.8	27172	72.68	143.90			

±15% at 20°C

DC Coil Ratings

Voltage (V)	Rated Current (mA)	Coil Resistance (Ω)	Coil Inductance (H) (reference value)		Operation Properties		
			Arm. OFF	Arm. ON	Released Voltage	Continuous Voltage	Operate Voltage
12V	43.2	278	0.98	2.35	10% min.	110% max	80% min.
24V	21.6	1100	3.60	8.25			
30V	27	1730	4.50	10.30			
110V	5.8	22830	19.2	32.10			

±15% at 20°C

Contact Ratings

Maximum Contact Capacity

Model	Continuous Current	Allowable Contact Power		Rated Load		
		Inductive Load	Resistive Load	Voltage	Ind. Load	Res. Load
SPDT	12A	1875VA AC 180W DC	3000VA AC 360W DC	250V AC	7.5 A	12 A
				30V DC	6A	12 A
				220V DC	–	0.5A
DPDT	5A	1000VA AC 120W DC	2000VA AC 240W DC	250V AC	2.5 A	5 A
				30V DC	2.5 A	5 A
				220V DC	–	0.2A

Specifications

Operating Temperature	SPDT	–40 to +70°C (No freezing)	
	DPDT	–40 to +70°C (No freezing)	
Contact Resistance	–	50mΩ maximum at 5V DC, 1A	
Operating Humidity	–	5% to 85% RH (No condensation)	
Insulation Resistance	–	1000MΩ minimum	
Dielectric Strength	SPDT DPDT	Between contact and coil:	5,000V AC, 1 minute
		Between contacts of different poles:	3,000V AC, 1 minute
		Between contacts of the same pole:	1,000V AC, 1 minute
Vibration Resistance	–	Damage limits:	10 to 55Hz, amplitude 0.75 mm
		Operating extremes:	10 to 55Hz, amplitude 0.75 mm
Shock Resistance	–	Damage limits:	1,000m/s ² (100G)
		Operating extremes:	NO contact: 200m/s ² (20G) NC contact: 100m/s ² (10G)
Mechanical Durability	–	AC coil: 30,000,000 operations minimum DC coil: 50,000,000 operations minimum	
Electrical Durability	–	AC load: 200,000 operations minimum DC load: 100,000 operations minimum	
Power Consumption (approx.)	SPDT	AC: 1.1VA (50Hz), 1.2VA (60Hz)	DC: 0.9W
	DPDT	AC: 1.4 VA (50 Hz), 1.2 VA (60 Hz)	DC: 0.9W
Operate Time	SPDT	15ms maximum at 20°C	
	DPDT	15ms maximum at 20°C	
Release Time	SPDT	10ms maximum at 20°C (with diode: 20 ms maximum)	
	DPDT	10ms maximum at 20°C (with diode: 20 ms maximum)	
Minimum Applicable Load	–	24V DC, 30 mA 5V DC, 100 mA (reference value)	
Contact Material	–	Silver cadmium oxide	
Operating Frequency	–	Electrical:	1,800 operations/hour maximum
		Mechanical:	18,000 operations/hour maximum
Weight (approx.)	–	20g	

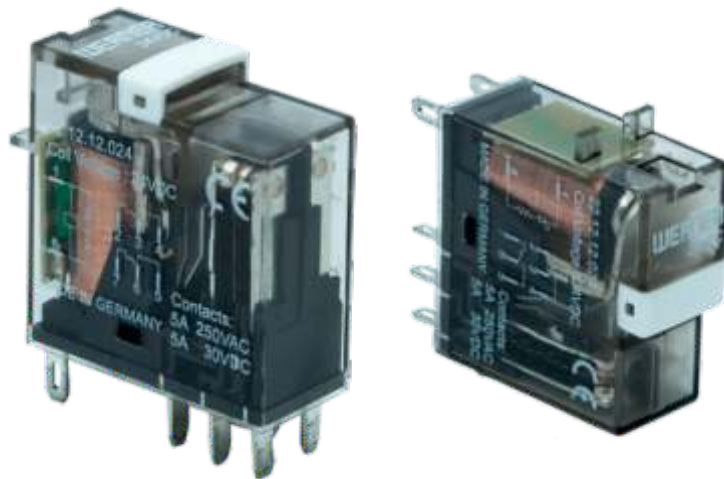

Model Number Structure - Relays

22.12.12.024

Series	
22 Series Relays	

Terminal Type	
1	Blade

Number of Poles	
1	SPDT
2	DPDT

Types	
0	Basic
1	LED
2	LED & Diode

Voltage	
012	12V
024	24V
030	30VDC
110	110V
230	230V

Coil	
1	AC
2	DC

Model Number Selection

Types	Voltage	Model No.		Model No.	
		SPDT		DPDT	
		AC	DC	AC	DC
Basic	12V	22.11.01.012	22.11.02.012	22.12.01.012	22.12.02.012
	24V	22.11.01.024	22.11.02.024	22.12.01.024	22.12.02.024
	30V	-	22.11.02.030	-	22.12.02.030
	110V	22.11.01.110	22.11.02.110	22.12.01.110	22.12.02.110
	230V	22.11.01.230	-	22.12.01.230	-
LED	12V	22.11.11.012	22.11.12.012	22.12.11.012	22.12.12.012
	24V	22.11.11.024	22.11.12.024	22.12.11.024	22.12.12.024
	30V	-	22.11.12.030	-	22.12.12.030
	110V	22.11.11.110	22.11.12.110	22.12.11.110	22.12.12.110
	230V	22.11.11.230	-	22.12.11.230	-
LED & Diode	12V	22.11.21.012	22.11.22.012	22.12.21.012	22.12.22.012
	24V	22.11.21.024	22.11.22.024	22.12.21.024	22.12.22.024
	30V	-	22.11.22.030	-	22.12.22.030
	110V	22.11.21.110	22.11.22.110	22.12.21.110	22.12.22.110
	230V	22.11.21.230	-	22.12.21.230	-

Dimensions

Blade Terminal

22.11 (SPDT)

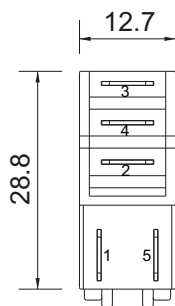

BOTTOM VIEW



FRONT VIEW

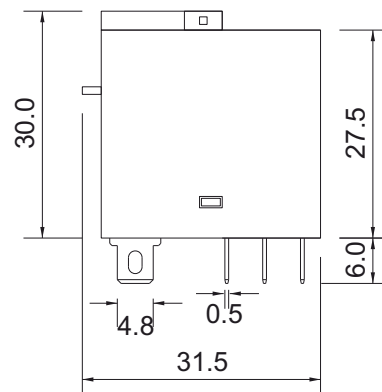

SIDE VIEW

22.12 (DPDT)

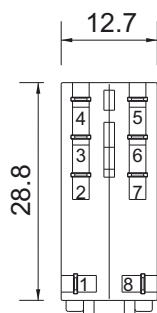

BOTTOM VIEW

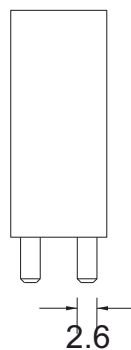

FRONT VIEW

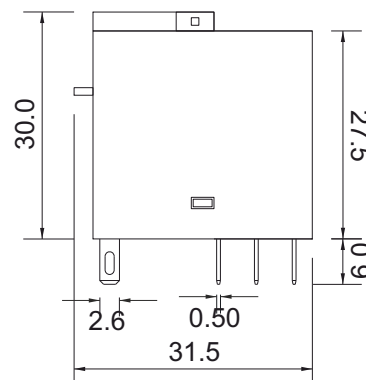

SIDE VIEW

Internal Connections

22.11 (SPDT)

Basic Type

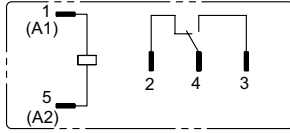

LED Type

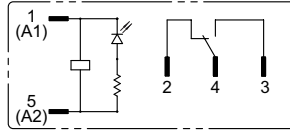

LED & Diode Type

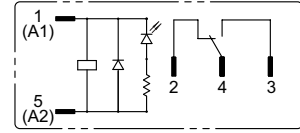

22.12 (DPDT)

Basic Type

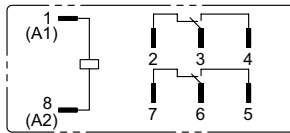

LED Type

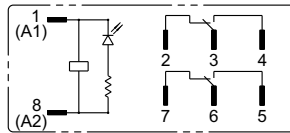

LED & Diode Type

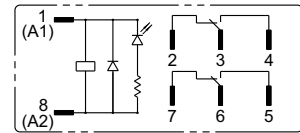

Switching Capacity

22.11 (SPDT)

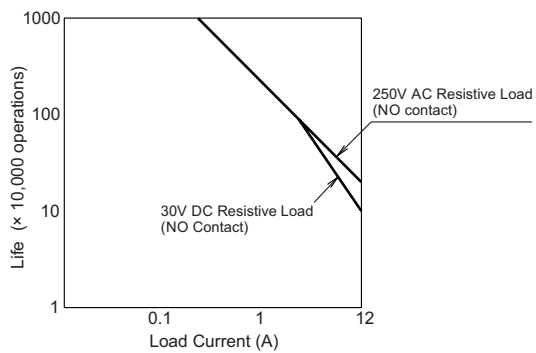

22.12 (DPDT)

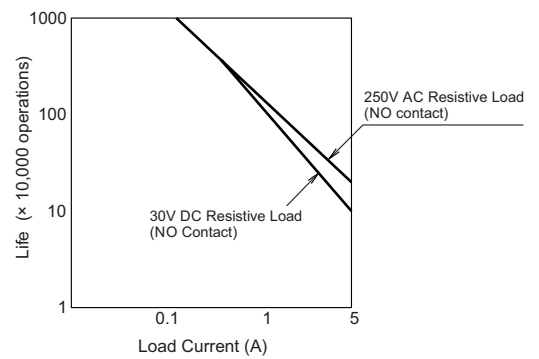

Electrical Characteristics

22.11 (SPDT)

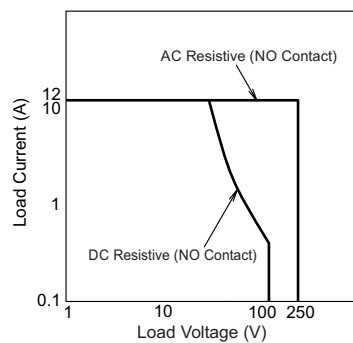

22.12 (DPDT)

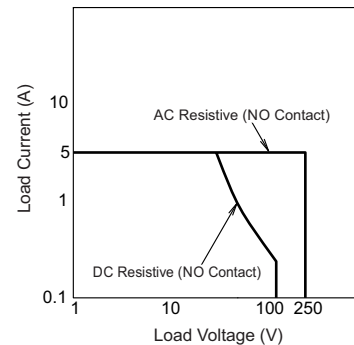

Accessories

DIN Rails

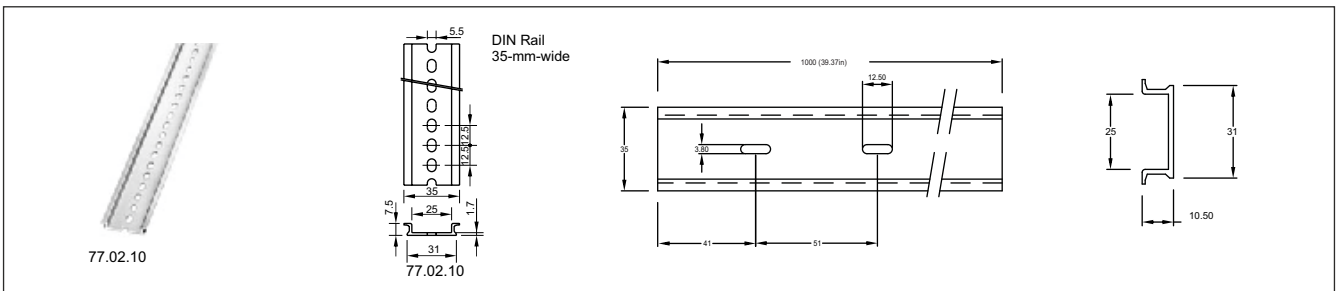

DIN Rail No.	Material	Length	Weight	Width
77.02.10	Aluminum	1000 mm	200 g	374" (9mm)

Socket Specification

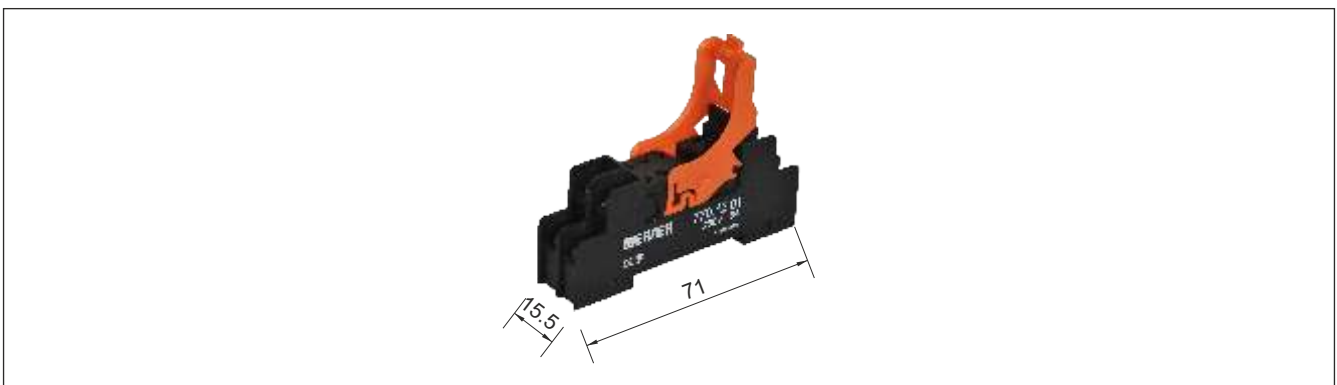

Mounting Type		Terminal	Torque	Wire Size	1 Pole	2 Poles
DIN Rail	Without Finger-safe	M3 screws	0.6 to 1.0 N.m	Up to 2.0mm ² (12AWG)	770.11.01	770.12.01

Mounting Clips

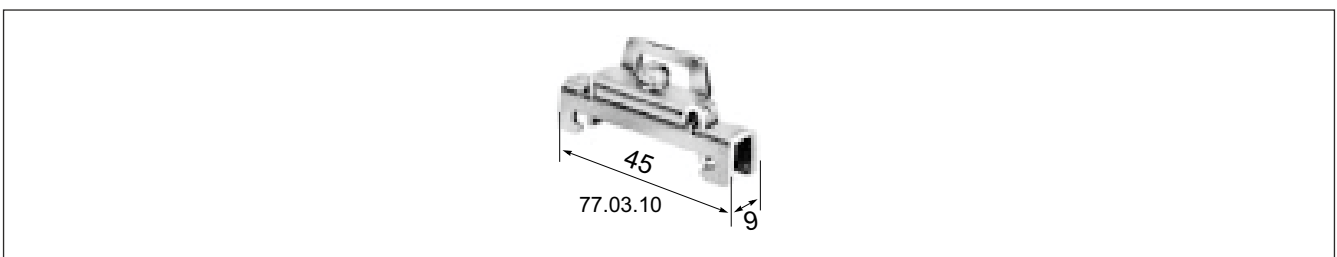

Mounting Clips No.	Rails	Width	Weight
77.03.10	77.02.10	45 mm	15.2 g

*dimensions are in mm

Instructions

Apply rated voltage to the relay coil to ensure correct relay type.
 When using a power supply containing a ripple voltage, suppress the ripple factor within 6% however, a complete DC voltage is best for the coil power to make sure of stable relay operation.
 Pickup voltage and dropout voltage depend on the ripple factor when power is supplied through a rectification circuit. Include a smoothing capacitor for better operation.

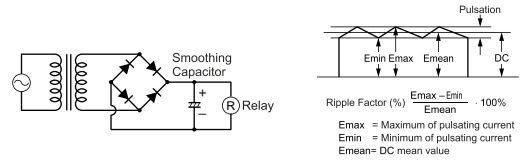

Special consideration should be taken when driving an element at the same time as the relay operation for the circuit design. Leakage current (I_o) flows through the relay coil while the relay is off. Leakage current causes coil release failure or adversely affects the vibration resistance and shock resistance. It is advisable to design a circuit as shown.



Connecting a diode to suppress at the back electromotive force prevents a high-voltage pulse which is generated when the relay coil is turned off, causing transistor to deteriorate or break, make sure the coil release time is slightly longer. To shorten the coil release time, connect a Zener diode which is slightly higher than the power voltage, between the collector and emitter of the transistor.

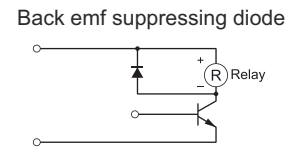

Protection

When an inrush current flows through the load, the contact may become welded. The contact ratings show maximum values, Make sure that these values are not exceeded. Connect a contact protection circuit, such as a current limiting resistor as a optional solution.

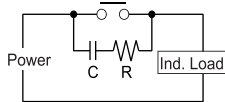

This protection circuit can be used when the load impedance is smaller than the RC impedance in an AC load power circuit.
 R: Resistor of approximately the same resistance value as the load
 C: 0.1 to 1 μ F

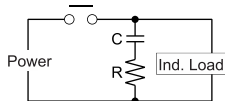

This protection circuit can be used for both AC and DC load power circuits.
 R: Resistor of approximately the same resistance value as the load
 C: 0.1 to 1 μ F

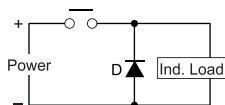

This protection circuit can be used for DC load power circuits. Use a diode with the following ratings.
 Reverse withstand voltage: Power voltage of the load circuit x 10
 Forward current: More than the load current.

Prevents

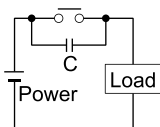

This protection circuit is very effective in arc suppression when opening the contact however, the capacitor is charged while the contacts are opened else the capacitor is discharged through the contacts, increasing the possibility of contact welding.

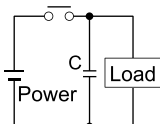

This protection circuit is very effective in arc suppression when opening the contact however, a current flows to charge the capacitor, causing contact welding when the contacts are closed.

Safety Precautions

- Do not drop, shock or remove the relay cover to maintain the initial characteristics.
- The relay cover should not be removed from the base during normal operation.
- Use the relay in environments free from dust, condensation, dioxide or hydrogen sulfide.
- Make sure that the coil voltage does not exceed applicable coil voltage range.
- Prevent usage of relays in the vicinity of strong magnetic field, as that may cause in malfunctioning of relays.
- Failure to turn off power before wiring, installation, removal and maintenance may cause electrical shock or fire hazard.
- Pay attention on specifications and rated values to prevent electrical shock or fire hazard.
- Use wires of the proper size to meet voltage and current requirements.
- Tighten the terminal screws on the relay socket to the proper tightening torque with a torque screw driver.

Terms And Conditions

Please read this catalog before purchasing any products. Please consult your *WERNER* representative for any clarifications or comments.

Application Considerations

WERNER shall not be responsible for conformity with any regulations, codes or standards that apply to use of the products. *WERNER* shall provide applicable third party certification documents identifying ratings and limitations of use that apply to the products in case of the customer's request.

Prevent use of the products for an application involving risk to life or property. Be sure that the *WERNER*'s products are properly rated and installed for the overall system or equipment.

WERNER shall not be responsible for the user's programming of a programmable products.

Warranty

WERNER's warranty represents that the products are free from defects in materials and workmanship for a period of one year.

WERNER shall not be responsible for any special loss of profit, commercial loss, indirect or consequential damages relevant to products.

WERNER shall not be responsible for repair, warranty or any claims regarding the products unless *WERNER*'s Analysis confirms that the products were properly stored, installed, handled, maintained and not a the results from accident, insufficient, abuse, misuse, natural disaster, improper installation excessive electrical supply, environmental conditions or abnormal mechanical.

Disclaimers

WERNER shall practice to change type/model numbers when published ratings or features are changed, however some specifications and international certifications of the products may be changed without any notice.

When in doubt, please consult with your *WERNER* representative to confirm actual specifications & approvals on the products.

WERNER shall change product specifications and accessories at any time based on improvements and other reasons.

The information in this catalog has been carefully checked. However, *WERNER* take no responsibilities for clerical, typographical or proofreading errors.

All marks and symbols used for representation in catalogues belongs to the respective owners.

Please check with *WERNER* representative for the available marks.



WERNER

Inventing Innovation...

H.Q.

Werner Electric Private Limited

#278/C, KIADB, Hebbal Industrial Area, Mysore-570018, India
Tel: +91 73539 47299, E-mail: info@wernerelektrik.com

Werner Malaysia Sdn Bhd,

45-2, Jalan Tiara 2B, Bandar Baru Klang,
41150, Klang, Selangor, Malaysia.

Tel: +60 13 533 3348, E-mail: info@wernerelektrik.com

Werner Elektrik Türkiye

Ayazağa Mah. Mimar Sinan Sok. Seba Office Boulevard.
D Blok. No.: 21D/45 Sarıyer / İstanbul, Türkiye.

Tekefon: +90 539 829 25 07 , E-posta: info@wernerelektrik.com

www.wernerelektrik.com