

WERNER

Inventing Innovation...

PRODUCT SPECIFICATION

770 Series Spring-Up Screw Terminal Block

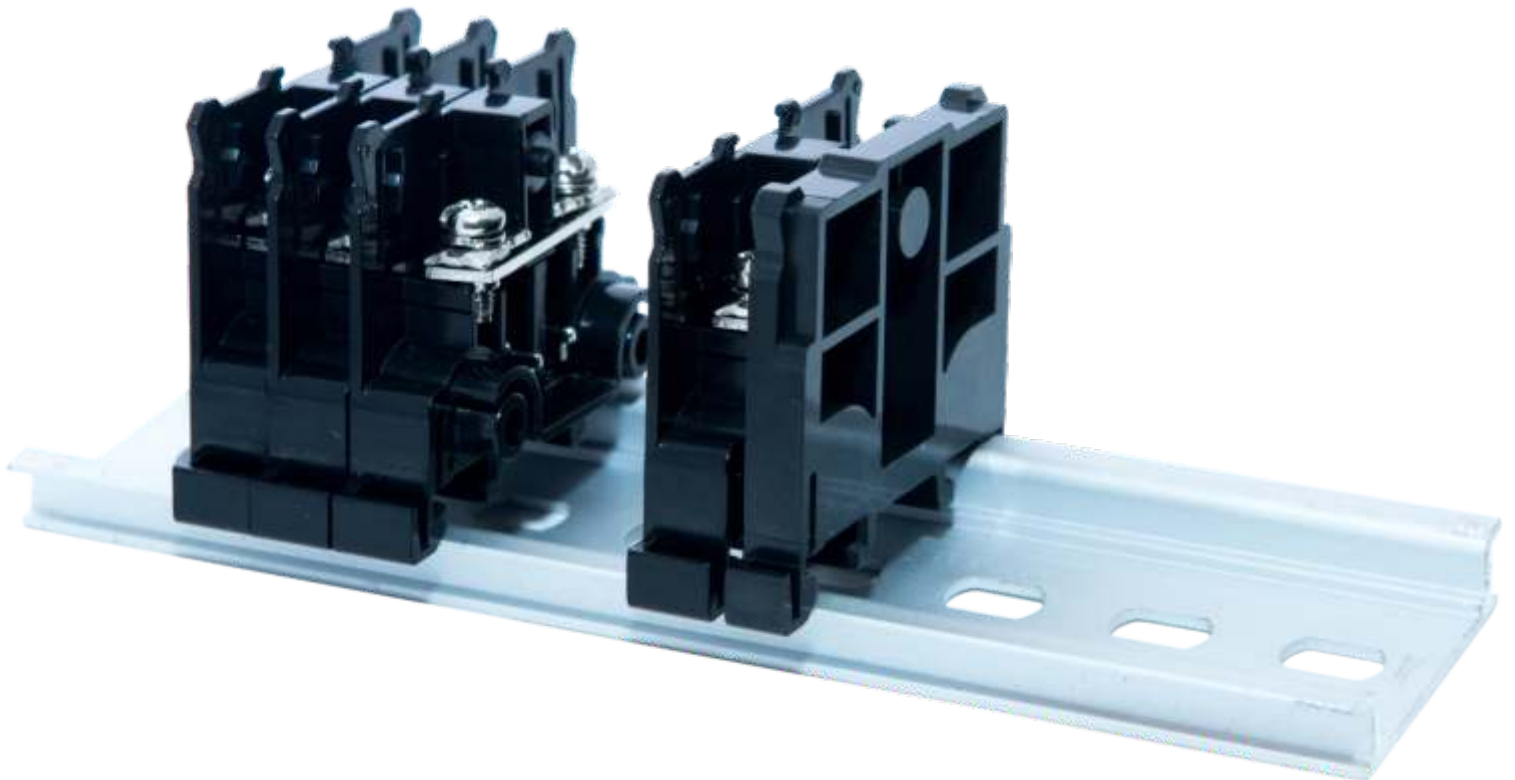

General Purpose & Model Selection	1
Technical Data & Specification	2
Accessories	3
Mounting Clips	5
Dimensions & Safety Precaution	6

General Purpose Terminal Blocks

Standard

Mount on a standard 35mm DIN rail
 Flame and shock resistance
 Variety of fuse blocks
 Marking strips and dust covers
 One-piece construction



Spring Lift

Mount on 35mm standard DIN rail
 Touch-down terminals with spring-loaded captive screws
 Fuse block with or without fuse indicator in LED or Neon.
 Up to 30A Jumper models

Approvals

CE

CE

Model Selection

Appearance	Model Number	Wire Size in (mm ²)	Voltage	Current
	770.00.16	2	600	16 A
	770.00.20	2	600	21 A
	770.00.40	5.5	600	40 A

770 Series Spring-Up Screw Terminal Blocks

WERNER

Technical Data - Standard & Specification

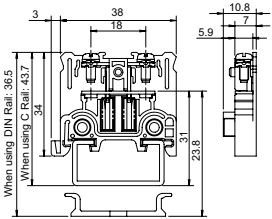
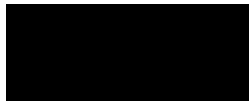
Model Numbers		770.00.16	770.00.20	770.00.40
Appearance				
Width		0.275" (7mm)	0.314" (8mm)	0.433" (11mm)
Dielectric Strength		2,500V AC, 1 minute	2,500V AC, 1 minute	2,500V AC, 1 minute
No. of Poles		1	1	1
Wire Sizes		22 to 14 AWG	22 to 14 AWG	18 to 10 AWG
Voltage/Current		600V / 16A	600V / 20A	600V / 40A
Terminals	Size	M3	M3.5	M4
	Type	Standard	Standard	Standard
Mounting		35mm DIN rail	35mm DIN rail	35mm DIN rail
Terminal Torque	(N-m)	0.6 - 1.0	1.0 - 1.3	1.4 - 2.0
	(in-lbs.)	5.3 - 8.9	8.9 - 11.5	12.4 - 17.8
End Plate		770.01.16	770.01.16	770.01.16
DIN Rail Stop - Aluminum		77.01.10	77.01.10	77.01.10
Dust Cover		77.05.30	77.05.30	77.05.30
Strip Marking	PVC	77.08.00	77.08.00	77.08.00
	End clip	77.01.01	77.01.01	77.01.03
Ring Terminal Jumpers		77.09.07	77.09.00	77.09.02
Fork Terminal Jumpers		77.09.17	77.09.10	77.09.12
Insulation Resistance		100 MΩ minimum	100 MΩ minimum	100 MΩ minimum
Operating Temperature		-25 to +55°C	-25 to +55°C	-25 to +55°C
Operating Humidity		45 to 85% RH	45 to 85% RH	45 to 85% RH
Dimensions				
Lug Dimensions				

770 Series Spring-Up Screw Terminal Blocks

WERNER

Accessories

End Plates

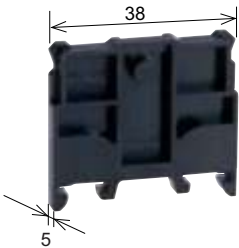
End Plate No.	770.01.16	
Weight	3 g	
Thickness	5 mm	
Applicable Terminal blocks	770.00.16 770.00.20 770.00.40	

DIN Rails

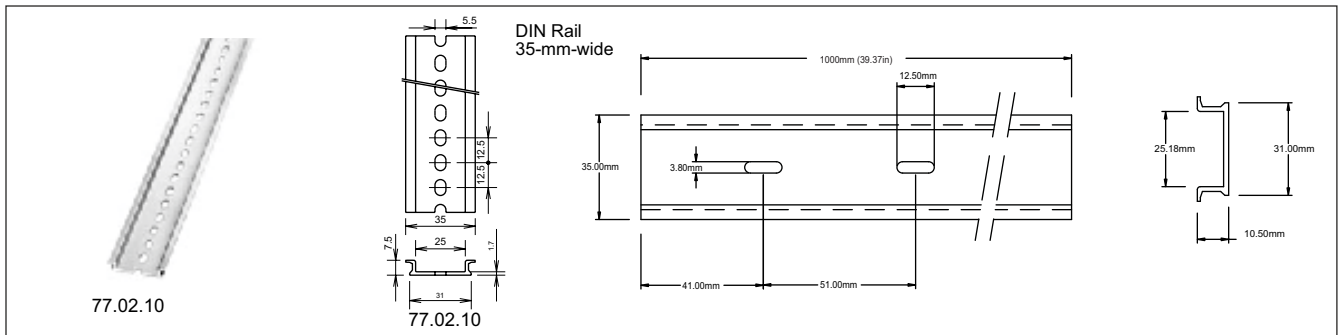

DIN Rail No.	Material	Length	Weight	Width
77.02.10	Aluminum	1000 mm	200 g	374" (9mm)

Marking Strip

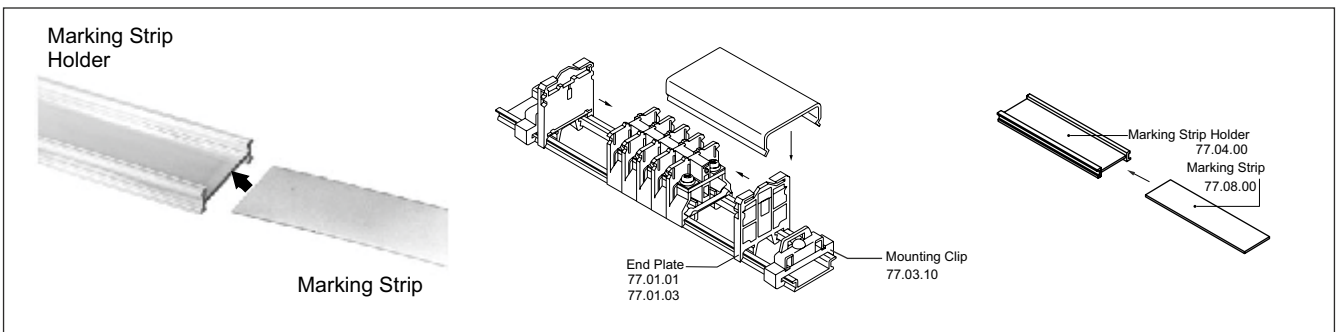

Elements	Type No.	Notes	Terminal Blocks
Marking Strip	77.08.00	PVC - Glossy Surface - 17 mm wide	770.00.16
Marking Strip Holder	77.04.00	1 m	770.00.20
Dust Cover	77.06.00	1 m	770.00.40
End Plate	77.01.01	sliding marking strip type	770.00.16 & 770.00.20
	77.01.03	sliding marking strip type	770.00.40

Dust Cover



77.05.30

Dust Cover No.	Length	Terminal Block	Weight
77.05.30	1 m	770.00.16 770.00.20 770.00.40	56 g

Jumper

Jumper No.	Jumper Type	Terminal Centers	Applicable Terminal Block	Current	Weight	Notes	Dimension
77.09.07	Ring	7 mm	770.00.16	10 A	3 g	With Black Color Insulation - PVC	
77.09.17	Fork	7 mm	770.00.16	10 A	3 g	With Black Color Insulation - PVC	
77.09.00	Ring	10.5 mm	770.00.20	20 A	6 g	With Black Color Insulation - PVC	
77.09.10	Fork	10.5 mm	770.00.20	20 A	6 g	With Black Color Insulation - PVC	
77.09.02	Ring	12 mm	770.00.40	30 A	6 g	With Black Color Insulation - PVC	
77.09.12	Fork	12 mm	770.00.40	30 A	6 g	With Black Color Insulation - PVC	

Mounting Clips Immediate Tightening

1

The terminal screw is always in the lifted position, ready for wiring. A ring terminal can be inserted easily.

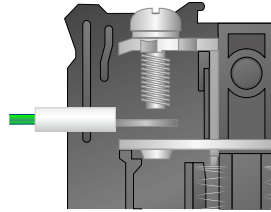

2

Push the terminal screw straight down to the bus bar using a screwdriver

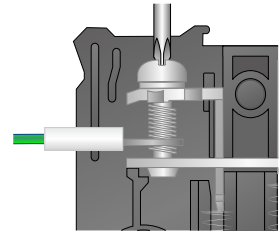

3

Tighten the terminal screw.

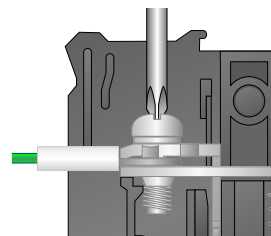

4

When loosening, the screw spring straight up

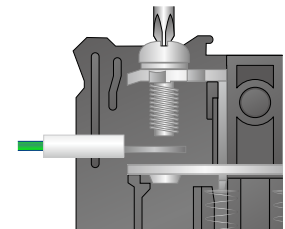

Mounting Clips Temporary Hold

1

The terminal screw is always in the lifted position, ready for wiring. A ring terminal can be inserted easily.

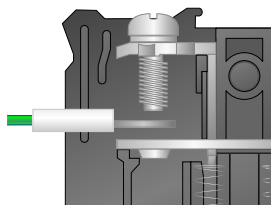

2

After pressing the terminal screw to the bus bar, tilt the terminal screw in the direction as shown.

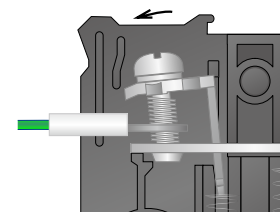

3

When tightening the screw, make sure that it is in upright position.

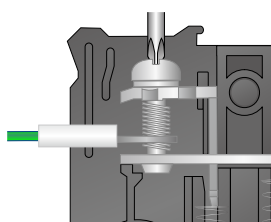

4

Tighten the terminal screw. If the screw stops at the temporary position, the screw will return to the original position by pushing further down.

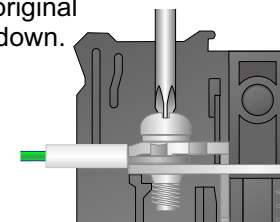

Dimensions

All dimensions in mm.

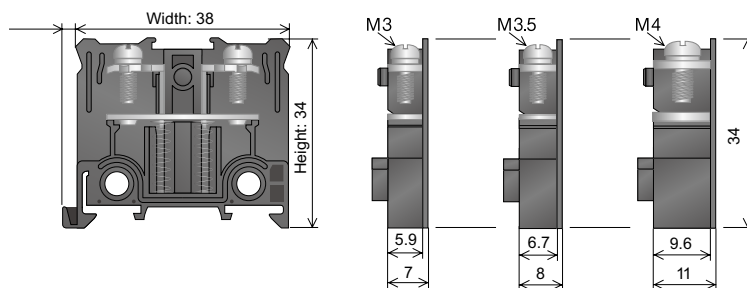

770.00.16 770.00.20 770.00.40

Safety Precaution

Removing the Terminal Blocks

When removing each block, disconnect the block on either side. Then, insert the flat screwdriver into the groove of the terminal block as shown

* Leave a space of about 5 mm.

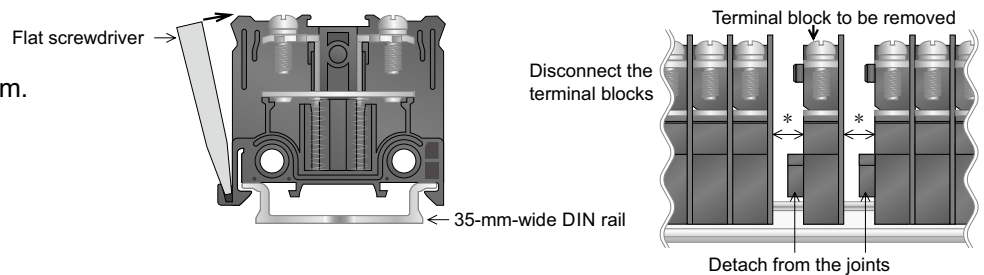

Terms And Conditions

Please read this catalog before purchasing any products. Please consult your *WERNER* representative for any clarifications or comments.

Application Considerations

WERNER shall not be responsible for conformity with any regulations, codes or standards that apply to use of the products. *WERNER* shall provide applicable third party certification documents identifying ratings and limitations of use that apply to the products in case of the customer's request.

Prevent use the products for an application involving risk to life or property. Be sure that the *WERNER*'s products are properly rated and installed for the overall system or equipment.

WERNER shall not be responsible for the user's programming of a programmable products.

Warranty

WERNER's warranty represents that the products are free from defects in materials and workmanship for a period of one year.

WERNER shall not be responsible for any special loss of profit, commercial loss, indirect or consequential damages relevant to products.

WERNER shall not be responsible for repair, warranty or any claims regarding the products unless *WERNER*'s Analysis confirm that the products were properly stored, installed, handled, maintained and not a result of accident, insufficient, abuse, misuse, natural disaster, improper installation excessive electrical supply, environmental conditions or abnormal mechanical.

Disclaimers

WERNER shall practice to change type/model numbers when published ratings or features are changed, however some specifications of the products may be changed without any notice.

When in doubt, please consult with your *WERNER* representative to confirm actual specifications of products.

WERNER shall change product specifications and accessories at any time based on improvements and other reasons.

The information in this catalog has been carefully checked and is believed to be accurate. However, *WERNER* take no responsibilities for clerical, typographical or proofreading errors.



WERNER

Inventing Innovation...

H.Q.

Werner Electric Private Limited

Plot No.: 166, Hebbal Industrial Area, Mysore - 570016, India.
Tel: +91 73539 47299, E-mail: info@wernerelektrik.com

Werner Malaysia Sdn Bhd,

45-2, Jalan Tiara 2B, Bandar Baru Klang,
41150, Klang, Selangor, Malaysia.

Tel: +60 13 533 3348, E-mail: info@wernerelektrik.com

Werner Elektrik Türkiye

Ayazağa Mah. Mimar Sinan Sok. Seba Office Boulevard.
D Blok. No.: 21D/45 Sariyer / İstanbul, Türkiye.

Tekefon: +90 539 829 25 07 , E-posta: info@wernerelektrik.com

www.wernerelektrik.com