

WERNER

Inventing Innovation...

Living Industrial Partnerships

PRODUCT SPECIFICATIONS

23 Series Power Relays



www.wernerelektrik.com

Technical Data	1
Specifications	2
Model Number Structure - Power Relays	3
Model Number Selection	4 - 5
Accessories	6
Mounting Clips	7
Electrical Characteristics	8
Safety Precautions.....	10

Power Relays



WERNER's 23 Series General Purpose & Power Relays represent the most complete line of state-of-the-art high performance electrical switches, designed and manufactured to highest international industry standards. Mechanical lifetimes of up to 10 Million operations and electrical durability of up to 250.000 switching cycles under full load make WERNER Relays your best choice of all.

Features Overview

- All models designed applying MFMS design principles (Max Function Min Space)
- All models designed applying solid modeling and finite elements design methods
- All Power Relay Series are equipped with mechanical operation status indicator
- All models approved under UL, CE, RoHS, CCC and DEMKO standards
- All models design for heavy duty or even vibrating environments
- All models available for use with 50 Hz and 60 Hz cycles

Highlights

- All fixed contacts powered by WERNER AFT (Anti-Fuse-Technology)
- All Power Relays Series provide massive silver blade or pin contacts
- Power Relay Series with up to 10 Ampere Continuous Load Current
- Most models available in 6V, 12V, 24V, 110V & 220V AC or DC
- Most models available in SPDT, DPDT, 3PDT as well as 4DPT
- Up to 5 types of operation status indication available

23 Series General Purpose & Power Relays by WERNER provide our highly demanding industrial customers out of all industry verticals worldwide with the most reliable devices in the industry. Combined with the vast selection of sockets in our 70 – 75 Product Series you will find an industrial solution exceeding your expectations whilst satisfying you're every need and design requirement.

Power Relays

Features:

- Power Relays - Heavy duty
- Dielectric strength 1,500V AC
- Current Capacity of 10A
- DIN Rail sockets are available
- 8 & 11 pin terminals
- DPDT, 3PDT



Approvals

Approbations and Declaration of conformity

CE CE

Overvoltage category

III, as per EN IEC 60947-5-1

AC Coil Ratings

Voltage (V)	Rated Current (mA)		Coil Resistance (Ω)	Operation Properties		
	AC 50Hz	AC 60Hz		Dropout Voltage	Pickup Voltage	Continuous Voltage
6V	490	420	4.9	30% min.	80% max	110% min.
12V	245	210	18			
24V	121	105	79			
48V	60	48	350			
110V	27	23	1,680			
120V	24	20.5	2,100			
220V	13.3	11.5	7,360			
240V	12.1	10.5	8,330			

±15% at 20°C

DC Coil Ratings

Voltage	Rated Current (mA)	Coil Resistance (Ω)	Operation Properties		
			Dropout Voltage	Pickup Voltage	Continuous Voltage
6V	240	25	15% min.	80% max.	110% max.
12V	120	100			
24V	60	400			
48V	30	1,600			
110V	13	8,460			
120V	-	-			
220V	-	-			
240V	-	-			

±15% at 20°C

23 Series Power Relays

Weight

Model No.	23.32 (DPDT)	23.33 (3PDT)
Weight (approx.)	90g	96g

Contact Ratings

Model	Continuous Current	Maximum Switching Power		Rated Load		
		Resistive Load	Inductive Load	Voltage (V)	Res. Load	Ind. Load
DPDT	10A	1650VA AC 300W DC	1100VA AC 150W DC	110V AC	10A	7.5A
				220V AC	7.5A	5A
				30V DC	10A	5A
3PDT	10A	1650VA AC 300W DC	1100VA AC 150W DC	110V AC	10A	7.5A
				220V AC	7.5A	5A
				30V DC	10A	5A

Specifications

Operating Temperature	-20 to +40°C (No freezing)	
Contact Resistance	30 mΩ maximum	
Operating Humidity	5 to 85% RH (no condensation)	
Insulation Resistance	100 MΩ minimum	
Dielectric Strength	Between live and dead parts:	1500V AC, 1 minute
	Between contact and coil:	1500V AC, 1 minute
	Between contacts of different poles:	1500V AC, 1 minute
	Between contacts of the same pole:	1000V AC, 1 minute
Vibration Resistance	Damage limits:	10 to 65 Hz, amplitude 0.5 mm
	Operating extremes:	10 to 65 Hz, amplitude 0.5 mm
Shock Resistance	Damage limits:	1000 m/s ²
	Operating extremes:	100 m/s ²
Mechanical Durability	10,000,000 operations	
Electrical Durability	200,000 operations	
Power Consumption (approx.)	AC:	3 VA (50 Hz), 2.5 VA (60 Hz)
	DC:	1.5W
Operate Time	25 ms maximum	
Release Time	25 ms maximum	
Minimum Applicable Load	1V DC, 10 mA	
Contact Material	Silver	
Operating Frequency	Electrical:	2000 operations/h maximum
	Mechanical:	20,000 operations/h maximum

Measured at 20° C Operating temperature

23 Series Power Relays

Model Number Structure - Power Relays



23.32.31.120

Series	
23 Series Relays	

Terminal Type	
3	Pin (Round)

Number of Poles	
2	DPDT
3	3PDT



Types		
0	Basic	
1	LED	
2	LED & Diode	DC Only
3	LED & Check button	
4	LED & Check button & Diode	DC Only
5	LED & RC	AC Only
6	LED & Check button & RC	AC Only

Voltage	
006	6V
012	12V
024	24V
048	48V
110	110V
120	120V
220	220V
240	240V

Coil	
1	AC
2	DC

23 Series Power Relays

Model Number Selection

Appearance	Terminal Type	Types	Voltage	Model No.	
				DPDT	AC
 <p>DPDT</p>  <p>3PDT</p>	Pin (Round)	Basic	6V	23.32.01.006	
			12V	23.32.01.012	
24V			23.32.01.024		
48V			23.32.01.048		
110V			23.32.01.110		
120V			23.32.01.120		
220V			23.32.01.220		
240V			23.32.01.240		
LED		6V	23.32.11.006		
		12V	23.32.11.012		
		24V	23.32.11.024		
		48V	23.32.11.048		
		110V	23.32.11.110		
		120V	23.32.11.120		
		220V	23.32.11.220		
		240V	23.32.11.240		
LED & Diode		6V	-		
		12V	-		
		24V	-		
		48V	-		
		110V	-		
		120V	-		
		220V	-		
		240V	-		
LED & Check button	6V	23.32.31.006			
	12V	23.32.31.012			
	24V	23.32.31.024			
	48V	23.32.31.048			
	110V	23.32.31.110			
	120V	23.32.31.120			
	220V	23.32.31.220			
	240V	23.32.31.240			
LED & Diode & Check button	6V	-			
	12V	-			
	24V	-			
	48V	-			
	110V	-			
	120V	-			
	220V	-			
	240V	-			
LED & RC	6V	-			
	12V	-			
	24V	-			
	48V	-			
	110V	-			
	120V	-			
	220V	-			
	240V	-			
LED & RC & Check button	6V	23.32.61.006			
	12V	23.32.61.012			
	24V	23.32.61.024			
	48V	23.32.61.048			
	110V	23.32.61.110			
	120V	23.32.61.120			
	220V	23.32.61.220			
	240V	23.32.61.240			

23 Series Power Relays

Model Number Selection

Model No.	Model No.	
DPDT	3PDT	
DC	AC	DC
23.32.02.006	23.33.01.006	23.33.02.006
23.32.02.012	23.33.01.012	23.33.02.012
23.32.02.024	23.33.01.024	23.33.02.024
23.32.02.048	23.33.01.048	23.33.02.048
23.32.02.110	23.33.01.110	23.33.02.110
23.32.02.120	23.33.01.120	23.33.02.120
23.32.02.220	23.33.01.220	23.33.02.220
23.32.02.240	23.33.01.240	23.33.02.240
23.32.12.006	23.33.11.006	23.33.12.006
23.32.12.012	23.33.11.012	23.33.12.012
23.32.12.024	23.33.11.024	23.33.12.024
23.32.12.048	23.33.11.048	23.33.12.048
23.32.12.110	23.33.11.110	23.33.12.110
23.32.12.120	23.33.11.120	23.33.12.120
23.32.12.220	23.33.11.220	23.33.12.220
23.32.12.240	23.33.11.240	23.33.12.240
23.32.22.006	–	23.33.22.006
23.32.22.012	–	23.33.22.012
23.32.22.024	–	23.33.22.024
23.32.22.048	–	23.33.22.048
23.32.22.110	–	23.33.22.110
23.32.22.120	–	23.33.22.120
23.32.22.220	–	23.33.22.220
23.32.22.240	–	23.33.22.240
23.32.32.006	23.33.31.006	23.33.32.006
23.32.32.012	23.33.31.012	23.33.32.012
23.32.32.024	23.33.31.024	23.33.32.024
23.32.32.048	23.33.31.048	23.33.32.048
23.32.32.110	23.33.31.110	23.33.32.110
23.32.32.120	23.33.31.120	23.33.32.120
23.32.32.220	23.33.31.220	23.33.32.220
23.32.32.240	23.33.31.240	23.33.32.240
23.32.42.006	–	23.33.42.006
23.32.42.012	–	23.33.42.012
23.32.42.024	–	23.33.42.024
23.32.42.048	–	23.33.42.048
23.32.42.110	–	23.33.42.110
23.32.42.120	–	23.33.42.120
23.32.42.220	–	23.33.42.220
23.32.42.240	–	23.33.42.240
–	23.33.51.006	–
–	23.33.51.012	–
–	23.33.51.024	–
–	23.33.51.048	–
–	23.33.51.110	–
–	23.33.51.120	–
–	23.33.51.220	–
–	23.33.51.240	–
–	23.33.61.006	–
–	23.33.61.012	–
–	23.33.61.024	–
–	23.33.61.048	–
–	23.33.61.110	–
–	23.33.61.120	–
–	23.33.61.220	–
–	23.33.61.240	–

23 Series Power Relays

UL - Voltage Ratings

Model	Resistive		General	
	DPDT	3PDT	DPDT	3PDT
240V AC	10A	10A	7A	7A
120V DC	10A	10A	7.5A	7.5A
30V DC	10A	10A	7A	7A

Accessories

DIN Rails

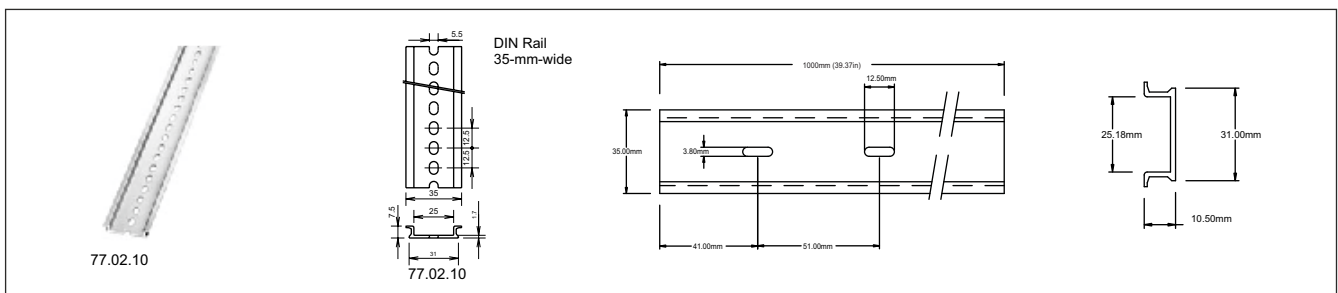

DIN Rail No.	Material	Length	Weight	Width
77.02.10	Aluminum	1000 mm	200 g	35 mm

Sockets - Blade Terminal Models

Socket Specifications

Mounting Type	Terminal	Torque	Wire Size	250V, 10A	
				2 Poles	3 Poles
DIN Rail	With Finger-safe M3 screws - coil M3.5 screws - contact	1.0 to 1.3 N.m	up to 2 - 14AWG	73.12.01	73.13.01
	Without Finger-safe M3 screws - coil M3.5 screws - contact	1.0 to 1.3 N.m	up to 2 - 14AWG	73.12.00	73.13.00

Poles	DPDT	3PDT
Voltage	250 V	250 V
A	10	10

Mounting Clips

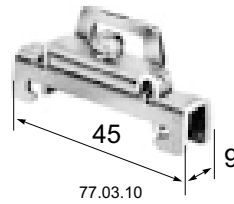

Mounting Clips No.	Rails	Width	Weight
77.03.10	77.02.10	45 mm	15.2 g

Applicable Clips

Appearance	Description	Relay	Suitable For DIN Mount Socket	Suitable For PCB Mount Socket
	Leaf Spring (top latch)	23.32 (DPDT)	73.03.01	73.03.02
		23.33 (3PDT)		
	Wire Spring	23.32 (DPDT)	73.02.01	73.02.02
		23.33 (3PDT)		

* For suitable relay please check Sockets catalogue.

Switching Capacity

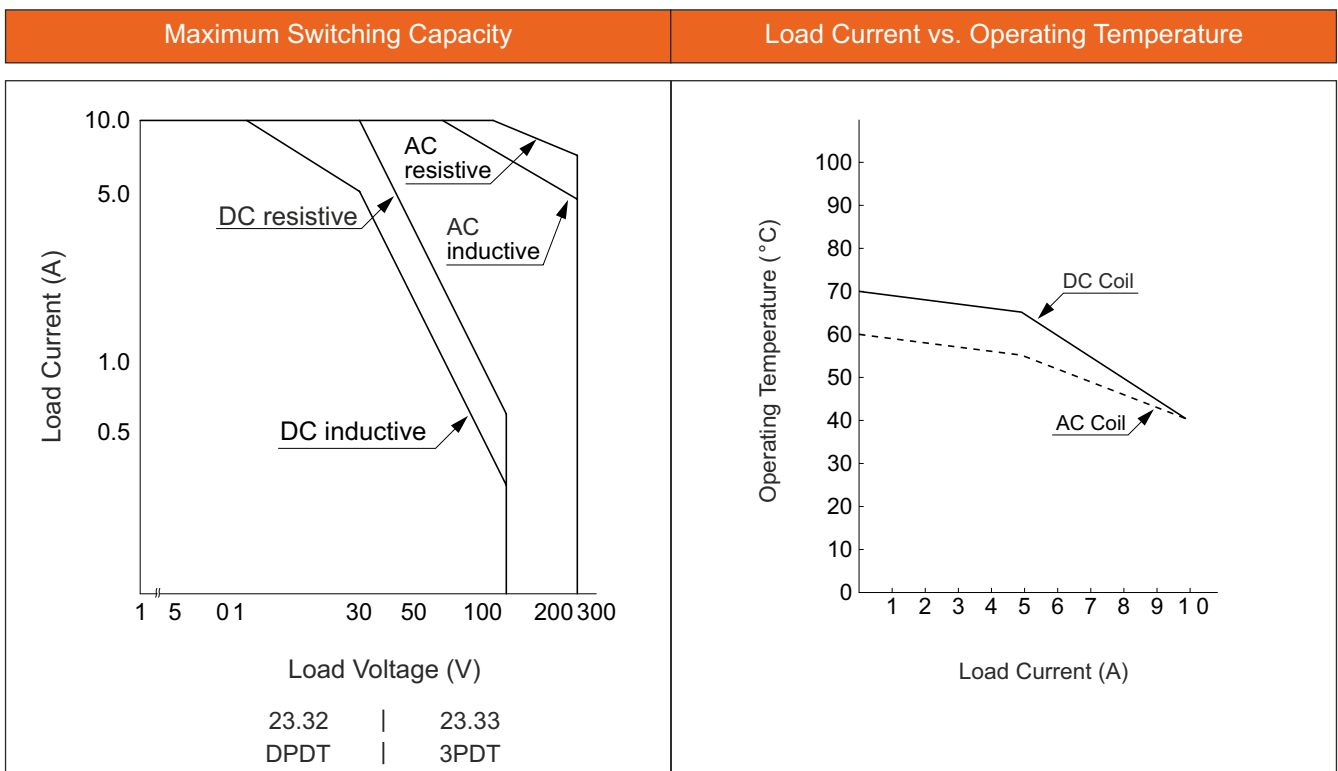

23 Series Power Relays

Electrical Characteristics

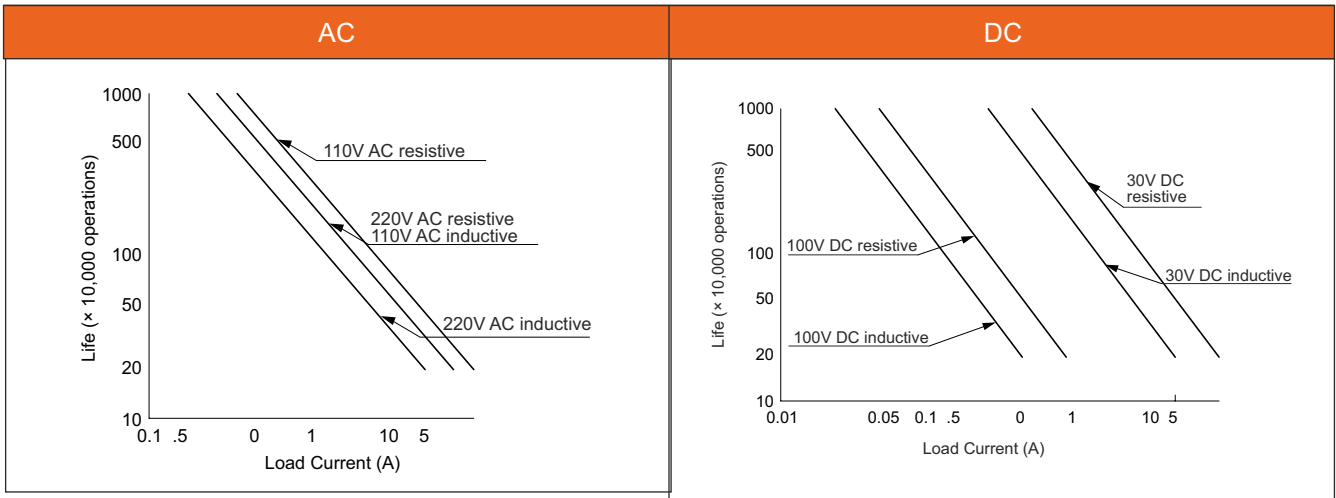

Dimensions

23.32 (DPDT)

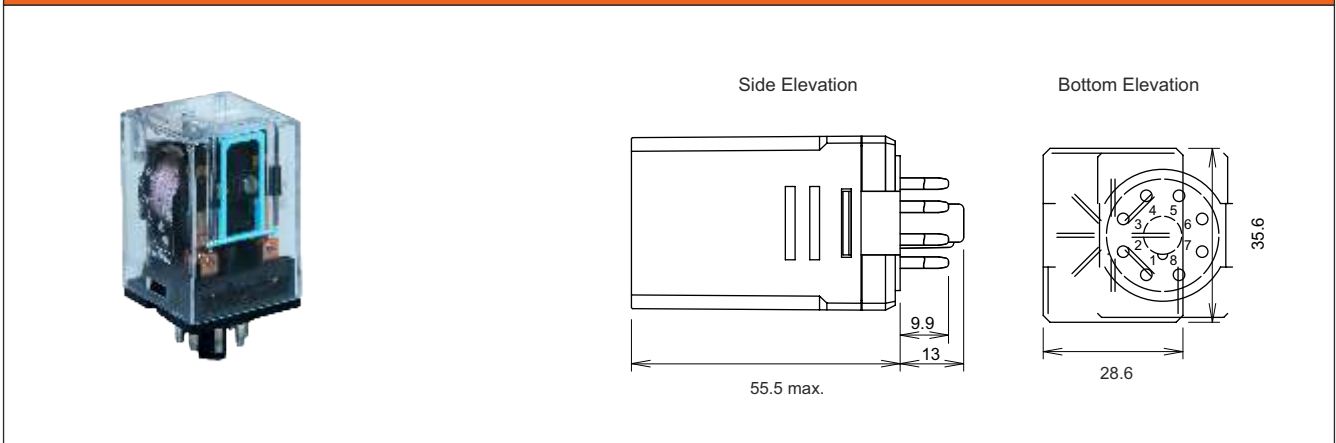

23.33 (3DPDT)

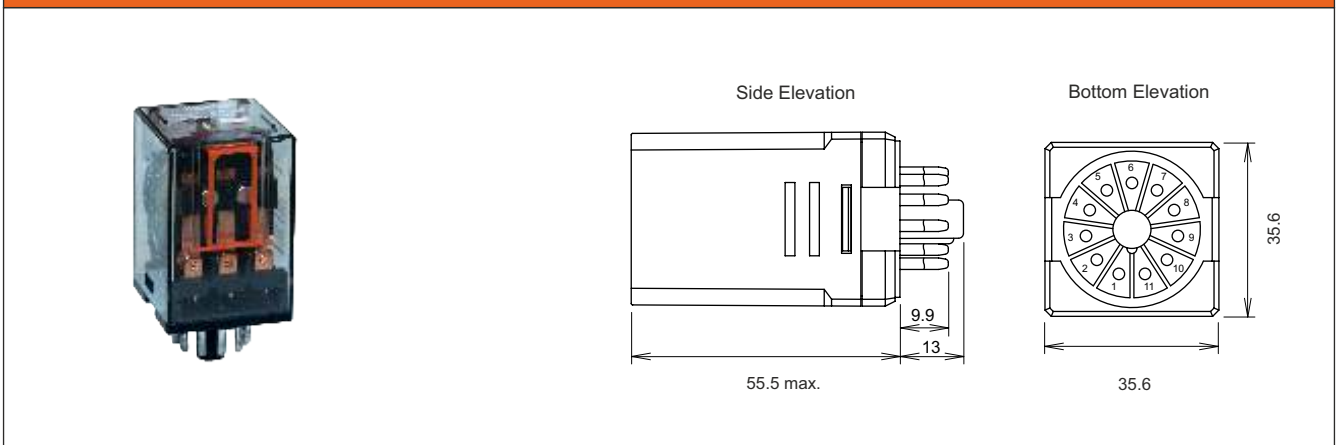

Basic Type - Internal Connection (Bottom View)

DPDT

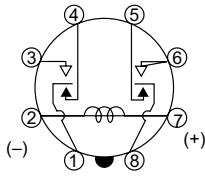

3PDT

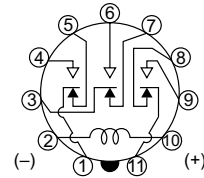

LED Type - Internal Connection (Bottom View)

DPDT

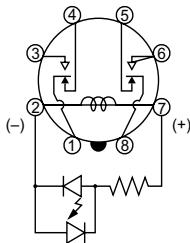

3PDT

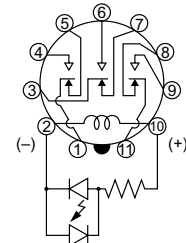

LED & RC Type - Internal Connection (Bottom View)

DPDT

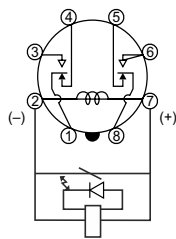

3PDT

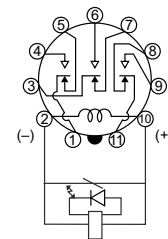

LED & Diode Type - Internal Connection (Bottom View)

DPDT

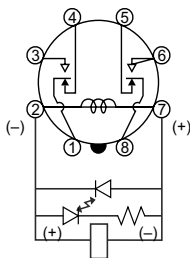

3PDT

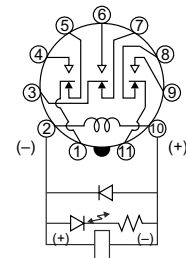

* Measured below 100V AC/DC.

Note: Relay Above 100V DC contain LED protection diode

Protection

When an inrush current flows through the load, the contact may become welded. The contact ratings show maximum values, Make sure that these values are not exceeded. Contact a contact protection circuit, such as a current limiting resistor as a optional solution.

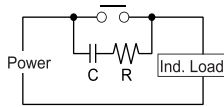

This protection circuit can be used when the load impedance is smaller than the RC impedance in an AC load power circuit.
R: Resistor of approximately the same resistance value as the load
C: 0.1 to 1 μF

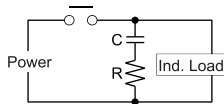

This protection circuit can be used for both AC and DC load power circuits.
R: Resistor of approximately the same resistance value as the load
C: 0.1 to 1 μF

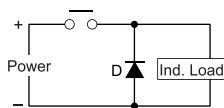

This protection circuit can be used for DC load power circuits. Use a diode with the following ratings.
Reverse withstand voltage: Power voltage of the load circuit x 10
Forward current: More than the load current.

Prevents

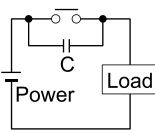

This protection circuit is very effective in arc suppression when opening the contact however, the capacitor is charged while the contacts are opened else the capacitor is discharged through the contacts, increasing the possibility of contact welding.

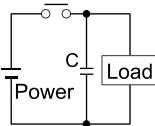

This protection circuit is very effective in arc suppression when opening the contact however, a current flows to charge the capacitor, causing contact welding when the contacts are closed.

Safety Precautions

Do not drop, shock or remove the relay cover to maintain the initial characteristics.
The relay cover cannot be removed from the base during normal operation.
Use the relay in environments free from dust, condensation, dioxide or hydrogen sulfide.

Make sure that the coil voltage does not exceed applicable coil voltage range.
Prevent usage of relays in the vicinity of strong magnetic field, as that may cause malfunctioning of relays.

Failure to turn off power before wiring, installation, removal and maintenance may cause electrical shock or fire hazard.

Attention on specifications and rated values to prevent electrical shock or fire hazard.
Use wires of the proper size to meet voltage and current requirements.

Tighten the terminal screws on the relay socket to the proper tightening torque.

Prevent using the check button as a switch.

The durability of the check button is a minimum of 200 operations.

It is advisable to apply a positive voltage to terminals of neighboring poles and a negative voltage to the other terminals of neighboring poles when using DC loads on 4PDT relays to prevent the possibility of short circuits.

A soldering iron of 30 to 60W would be recommended when soldering the relay terminals and the preferred time to complete soldering is within 4 seconds approximately.

Terms And Conditions

Please read this catalog before purchasing any products. Please consult your *WERNER* representative for any clarifications or comments.

Application Considerations

WERNER shall not be responsible for conformity with any regulations, codes or standards that apply to use of the products. *WERNER* shall provide applicable third party certification documents identifying ratings and limitations of use that apply to the products in case of the customer's request.

Prevent use the products for an application involving risk to life or property. Be sure that the *WERNER*'s products are properly rated and installed for the overall system or equipment.

WERNER shall not be responsible for the user's programming of a programmable products.

Warranty

WERNER's warranty represents that the products are free from defects in materials and workmanship for a period of one year.

WERNER shall not be responsible for any special loss of profit, commercial loss, indirect or consequential damages relevant to products.

WERNER shall not be responsible for repair, warranty or any claims regarding the products unless *WERNER*'s Analysis confirm that the products were properly stored, installed, handled, maintained and not a result of accident, insufficient, abuse, misuse, natural disaster, improper installation excessive electrical supply, environmental conditions or abnormal mechanical.

Disclaimers

WERNER shall practice to change type/model numbers when published ratings or features are changed, however some specifications of the products may be changed without any notice.

When in doubt, please consult with your *WERNER* representative to confirm actual specifications of products.

WERNER shall change product specifications and accessories at any time based on improvements and other reasons.

The information in this catalog has been carefully checked. However, *WERNER* take no responsibilities for clerical, typographical or proofreading errors.

WERNER

Inventing Innovation

Product specifications are subject to change without notice.

Thank you for choosing *WERNER* products.

Note:-



WERNER

Inventing Innovation...

H.Q.

Werner Electric Private Limited

Plot No.: 166, Hebbal Industrial Area, Mysore - 570016, India.
Tel: +91 73539 47299, E-mail: info@wernerelektrik.com

Werner Malaysia Sdn Bhd,

45-2, Jalan Tiara 2B, Bandar Baru Klang,
41150, Klang, Selangor, Malaysia.

Tel: +60 13 533 3348, E-mail: info@wernerelektrik.com

Werner Elektrik Türkiye

Ayazağa Mah. Mimar Sinan Sok. Seba Office Boulevard.
D Blok. No.: 21D/45 Sariyer / İstanbul, Türkiye.

Tekefon: +90 539 829 25 07 , E-posta: info@wernerelektrik.com

www.wernerelektrik.com