

PRODUCT SPECIFICATION

50 Series Miniature Circuit Breakers



MCB Technical Data.....	1
Temperature Characteristics	2
Let-through Properties	3
Model Number Structure.....	4
Model Number Selection - Breaking Capacity Properties.....	5 - 8
Auxiliary	9
MCB Dimensions.....	10
Auxiliary Dimensions.....	11

Miniature Circuit Breakers

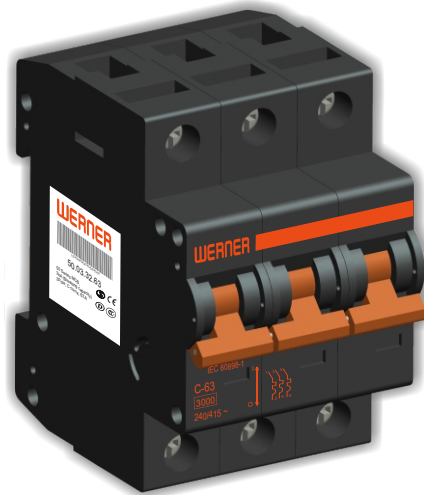

WERNER'S 50 series miniature circuit breakers provide the customer a comprehensive efficient, reliable protection of equipments, cables and installations in buildings for over load and short circuit faults.

Features Overview

- MCB's of 17.5mm pole width
- Ideal protection for overload & short circuit
- Available in single, double, triple & four poles
- Current ratings ranging from 2 amps to 63 amps
- Available in B, C, D curves with S/C breaking capacities 3, 4.5, 6 & 10 KA

Highlights

- Compact and Din mountable.
- High mechanical and electrical life enhances reliability and savings on investment.
- Auxiliary contact, trip indicating, under voltage and shunt release blocks are available.

Ranging from 2 Amps to 63 Amps in single, double, triple and four pole versions, 50 series miniature circuit breakers are with uniform switching capacity of 3 KA, 4.5 KA, 6 KA and 10 KA throughout in three different tripping characteristics B, C & D curves provide the ideal solution for all applications from semiconductor protection to cable protection, up to the protection of control transformers.

The finger touch proofs terminals provide installation safety and combined terminals allow bus bar and feeder cable to be simultaneously connected. 50 series MCB's can be mounted in any position.

50 Series Miniature Circuit Breaker

WERNER

50 Series Miniature Circuit Breaker

Features:

- Available in 1, 2, 3 & 4 Poles with High efficiency
- Great overload and short circuit protection
- Mechanical life span up to 12000 Operations
- Available in B, C & D Curve with Breaking Capacity of 3, 4.5, 6 & 10 kA

Over voltage category

III, as per EN IEC 60947-5-1

Approvals

Approbations and Declaration of conformity

CE

CE



Technical Data

Miniature Circuit Breakers				Curve B 50.03.11.63	Curve C 50.03.12.63	Curve D 50.03.13.63
Isolating properties						✓
Terminal capacity	Solid or stranded	Min./Max.	mm ²			1x (1 – 25)
		Min./Max.	mm ²			2x (1 – 10)
	Flexible, with ferrule	Min./Max.	mm ²			1x (0.75 – 16)
		Min./Max.	mm ²			2x (4 – 6)
Mechanical shock resistance (shock duration 20 ms)			g			10
Ambient temperature		Min./Max.	°C			-5/+50
Mounting position/direction of incoming supply						As required
Tightening torque			Nm			2.4
Degree of protection against electric shock IEC60898-1						IP40
Degree of protection (terminals)						IP20

Weight

Weight per pole		kg	0.11
-----------------	--	----	------

Switching Capacity

Rated short-circuit breaking capacity I_{cn}	230/400 V AC,	2 – 50	kA	10/10	10/10	10/10
	240/415 V AC	63	kA	10/8	10/8	–
	48 V DC	2 – 50	kA	10	10	10
	(T = 4 ms)	63	kA	8	8	–
	Single-pole for 400 V		kA	1	1	1
With LV h.b.c. fuses, max. gG/gL			A/kA	100 ≥ 10	100 ≥ 10	100 ≥ 10
Mechanical lifespan		Operations	x 2 switching movements	≥ 5000	≥ 5000	≥ 5000

Contact Specification

Rated frequency		Hz	50 to 60	50 to 60	50 to 60
Rated impulse withstand voltage U_{imp}		V	4000	4000	4000
Rated current I_n = rated uninterrupted current I_u		A	2 – 63	2 – 63	2 – 63
Rated insulation voltage U_i		VAC	440	440	440
Rated operational voltage U_e		VAC	240 / 415	240 / 415	240 / 415
B, C & D properties / pole	DC	VDC	48	48	48

Temperature Characteristics

Curve I _n [A]	Ambient Temperature							Rated heat dissipation/pole [W]
	30°C	35°C	40°C	45°C	50°C	55°C	60°C	
B 50.03.11. **								
C 50.03.12. **								
D 50.03.13. **								
02	02	2.0	1.9	1.9	1.8	1.8	1.8	1.4
04	04	3.9	3.8	3.8	3.7	3.6	3.5	1.2
06	06	5.9	5.8	5.6	5.5	5.4	5.3	1.8
10	10	9.8	9.6	9.4	9.2	9.0	8.8	2.1
16	16	15.7	15.4	15.0	14.7	14.4	14.1	2.0
20	20	19.6	19.2	18.8	18.4	18.0	17.6	2.9
25	25	24.5	24.0	23.5	23.0	22.5	22.0	3.1
32	32	31.4	30.7	30.1	29.4	28.8	28.2	3.1
40	40	39.2	38.4	37.6	36.8	36.0	35.2	4.2
50	50	49.0	48.0	47.0	46.0	45.0	44.0	4.6
63	63	61.7	60.5	59.2	58.0	56.7	55.4	5.3

Ordering Information

In place of ** choose the appropriate ratings

Ex. for 3 kA Capacity, 3 poles, C curve with 30 A rating : 50.03.32.30.

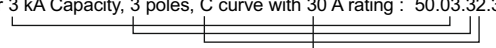

For more selection refer to "model number structure" in page - 4.

Load carrying capacity of 50 Series

Diversity factor at β , which indicates the miniature circuit-breakers mounted beside each other by influencing at rated load.

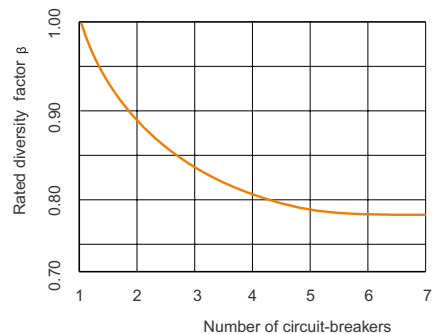

Tripping Properties

30°C - B,C & D Curve to IEC 60898-1

Specified tripping current
 $I_t = 1.45 I_n$ for $t < 1$ h

Specified non-tripping current
 $I_{nt} = 1.13 I_n$ for $t > 1$ h

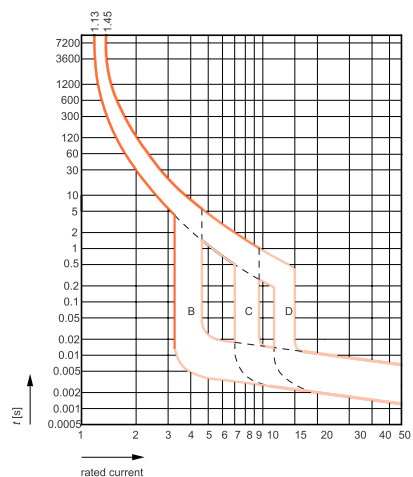

Let-through Properties

Curve B & C

Energy $I^2 t$

Current \hat{I}_D

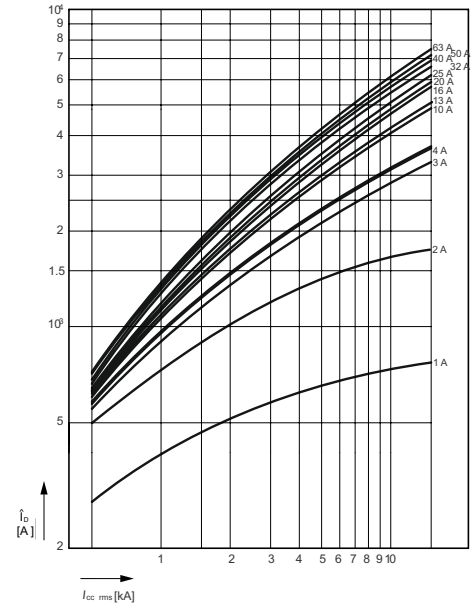
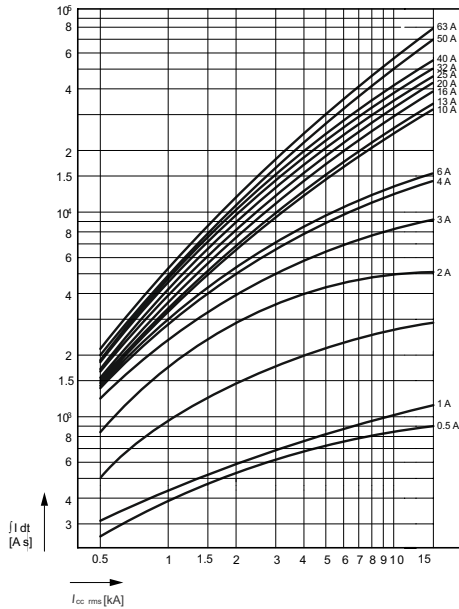

Curve D

Energy $I^2 t$

Current \hat{I}_D

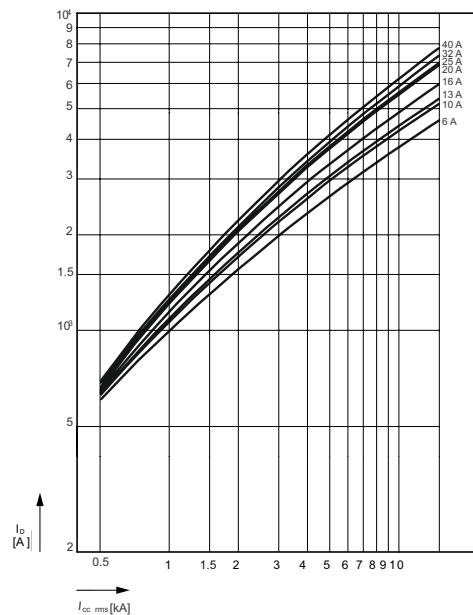
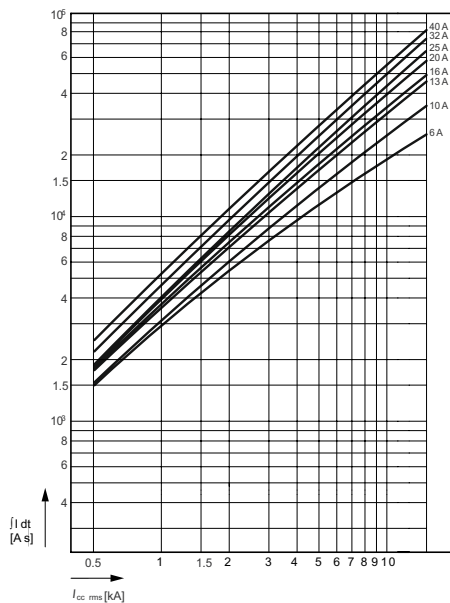

50 Series Miniature Circuit Breaker

Model Number Structure

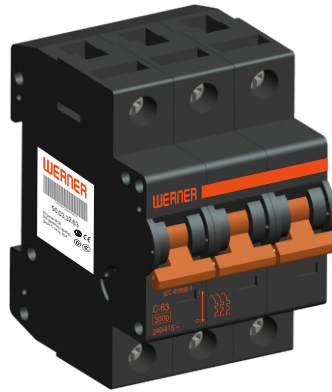

50.03.32.63

50 Series	
Miniature Circuit Breaker	

Breaking Capacity	
03	3 kA
04	4.5 kA
06	6 kA
10	10 kA

No. of Poles	
1	1 Pole
2	2 Poles
3	3 Poles
4	4 Poles

Ratings	
02	2 A
04	4 A
06	6 A
10	10 A
16	16 A
20	20 A
25	25 A
32	32 A
40	40 A
50	50 A
63	63 A

Tripping Curve	
1	B
2	C
3	D

50 Series Miniature Circuit Breaker

WERNER

Model Number Selection

Breaking Capacity $I_{cn} = 3 \text{ kA}$

1 POLE

	In (A)	Curve B	Curve C	Curve D
	2	50.03.11.02	50.03.12.02	50.03.13.02
	4	50.03.11.04	50.03.12.04	50.03.13.04
	6	50.03.11.06	50.03.12.06	50.03.13.06
	10	50.03.11.10	50.03.12.10	50.03.13.10
	16	50.03.11.16	50.03.12.16	50.03.13.16
	20	50.03.11.20	50.03.12.20	50.03.13.20
	25	50.03.11.25	50.03.12.25	50.03.13.25
	32	50.03.11.32	50.03.12.32	50.03.13.32
	40	50.03.11.40	50.03.12.40	50.03.13.40
	50	50.03.11.50	50.03.12.50	50.03.13.50
	63	50.03.11.63	50.03.12.63	50.03.13.63

2 POLES

	In (A)	Curve B	Curve C	Curve D
	2	50.03.21.02	50.03.22.02	50.03.23.02
	4	50.03.21.04	50.03.22.04	50.03.23.04
	6	50.03.21.06	50.03.22.06	50.03.23.06
	10	50.03.21.10	50.03.22.10	50.03.23.10
	16	50.03.21.16	50.03.22.16	50.03.23.16
	20	50.03.21.20	50.03.22.20	50.03.23.20
	25	50.03.21.25	50.03.22.25	50.03.23.25
	32	50.03.21.32	50.03.22.32	50.03.23.32
	40	50.03.21.40	50.03.22.40	50.03.23.40
	50	50.03.21.50	50.03.22.50	50.03.23.50
	63	50.03.21.63	50.03.22.63	50.03.23.63

3 POLES

	In (A)	Curve B	Curve C	Curve D
	2	50.03.31.02	50.03.32.02	50.03.33.02
	4	50.03.31.04	50.03.32.04	50.03.33.04
	6	50.03.31.06	50.03.32.06	50.03.33.06
	10	50.03.31.10	50.03.32.10	50.03.33.10
	16	50.03.31.16	50.03.32.16	50.03.33.16
	20	50.03.31.20	50.03.32.20	50.03.33.20
	25	50.03.31.25	50.03.32.25	50.03.33.25
	32	50.03.31.32	50.03.32.32	50.03.33.32
	40	50.03.31.40	50.03.32.40	50.03.33.40
	50	50.03.31.50	50.03.32.50	50.03.33.50
	63	50.03.31.63	50.03.32.63	50.03.33.63

4 POLES

	In (A)	Curve B	Curve C	Curve D
	2	50.03.41.02	50.03.42.02	50.03.43.02
	4	50.03.41.04	50.03.42.04	50.03.43.04
	6	50.03.41.06	50.03.42.06	50.03.43.06
	10	50.03.41.10	50.03.42.10	50.03.43.10
	16	50.03.41.16	50.03.42.16	50.03.43.16
	20	50.03.41.20	50.03.42.20	50.03.43.20
	25	50.03.41.25	50.03.42.25	50.03.43.25
	32	50.03.41.32	50.03.42.32	50.03.43.32
	40	50.03.41.40	50.03.42.40	50.03.43.40
	50	50.03.41.50	50.03.42.50	50.03.43.50
	63	50.03.41.63	50.03.42.63	50.03.43.63

50 Series Miniature Circuit Breaker

WERNER

Model Number Selection

Breaking Capacity $I_{cn} = 4.5 \text{ kA}$

1 POLE

	In (A)	Curve B	Curve C	Curve D
	2	50.04.11.02	50.04.12.02	50.04.13.02
	4	50.04.11.04	50.04.12.04	50.04.13.04
	6	50.04.11.06	50.04.12.06	50.04.13.06
	10	50.04.11.10	50.04.12.10	50.04.13.10
	16	50.04.11.16	50.04.12.16	50.04.13.16
	20	50.04.11.20	50.04.12.20	50.04.13.20
	25	50.04.11.25	50.04.12.25	50.04.13.25
	32	50.04.11.32	50.04.12.32	50.04.13.32
	40	50.04.11.40	50.04.12.40	50.04.13.40
	50	50.04.11.50	50.04.12.50	50.04.13.50
63	50.04.11.63	50.04.12.63	50.04.13.63	

2 POLES

	In (A)	Curve B	Curve C	Curve D
	2	50.04.21.02	50.04.22.02	50.04.23.02
	4	50.04.21.04	50.04.22.04	50.04.23.04
	6	50.04.21.06	50.04.22.06	50.04.23.06
	10	50.04.21.10	50.04.22.10	50.04.23.10
	16	50.04.21.16	50.04.22.16	50.04.23.16
	20	50.04.21.20	50.04.22.20	50.04.23.20
	25	50.04.21.25	50.04.22.25	50.04.23.25
	32	50.04.21.32	50.04.22.32	50.04.23.32
	40	50.04.21.40	50.04.22.40	50.04.23.40
	50	50.04.21.50	50.04.22.50	50.04.23.50
63	50.04.21.63	50.04.22.63	50.04.23.63	

3 POLES

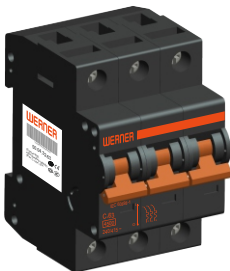
	In (A)	Curve B	Curve C	Curve D
	2	50.04.31.02	50.04.32.02	50.04.33.02
	4	50.04.31.04	50.04.32.04	50.04.33.04
	6	50.04.31.06	50.04.32.06	50.04.33.06
	10	50.04.31.10	50.04.32.10	50.04.33.10
	16	50.04.31.16	50.04.32.16	50.04.33.16
	20	50.04.31.20	50.04.32.20	50.04.33.20
	25	50.04.31.25	50.04.32.25	50.04.33.25
	32	50.04.31.32	50.04.32.32	50.04.33.32
	40	50.04.31.40	50.04.32.40	50.04.33.40
	50	50.04.31.50	50.04.32.50	50.04.33.50
63	50.04.31.63	50.04.32.63	50.04.33.63	

4 POLES

	In (A)	Curve B	Curve C	Curve D
	2	50.04.41.02	50.04.42.02	50.04.43.02
	4	50.04.41.04	50.04.42.04	50.04.43.04
	6	50.04.41.06	50.04.42.06	50.04.43.06
	10	50.04.41.10	50.04.42.10	50.04.43.10
	16	50.04.41.16	50.04.42.16	50.04.43.16
	20	50.04.41.20	50.04.42.20	50.04.43.20
	25	50.04.41.25	50.04.42.25	50.04.43.25
	32	50.04.41.32	50.04.42.32	50.04.43.32
	40	50.04.41.40	50.04.42.40	50.04.43.40
	50	50.04.41.50	50.04.42.50	50.04.43.50
63	50.04.41.63	50.04.42.63	50.04.43.63	

50 Series Miniature Circuit Breaker

WERNER

Model Number Selection

Breaking Capacity $I_{cn} = 6 \text{ kA}$

1 POLE

	In (A)	Curve B	Curve C	Curve D
	2	50.06.11.02	50.06.12.02	50.06.13.02
	4	50.06.11.04	50.06.12.04	50.06.13.04
	6	50.06.11.06	50.06.12.06	50.06.13.06
	10	50.06.11.10	50.06.12.10	50.06.13.10
	16	50.06.11.16	50.06.12.16	50.06.13.16
	20	50.06.11.20	50.06.12.20	50.06.13.20
	25	50.06.11.25	50.06.12.25	50.06.13.25
	32	50.06.11.32	50.06.12.32	50.06.13.32
	40	50.06.11.40	50.06.12.40	50.06.13.40
	50	50.06.11.50	50.06.12.50	50.06.13.50
63	50.06.11.63	50.06.12.63	50.06.13.63	

2 POLES

	In (A)	Curve B	Curve C	Curve D
	2	50.06.21.02	50.06.22.02	50.06.23.02
	4	50.06.21.04	50.06.22.04	50.06.23.04
	6	50.06.21.06	50.06.22.06	50.06.23.06
	10	50.06.21.10	50.06.22.10	50.06.23.10
	16	50.06.21.16	50.06.22.16	50.06.23.16
	20	50.06.21.20	50.06.22.20	50.06.23.20
	25	50.06.21.25	50.06.22.25	50.06.23.25
	32	50.06.21.32	50.06.22.32	50.06.23.32
	40	50.06.21.40	50.06.22.40	50.06.23.40
	50	50.06.21.50	50.06.22.50	50.06.23.50
63	50.06.21.63	50.06.22.63	50.06.23.63	

3 POLES

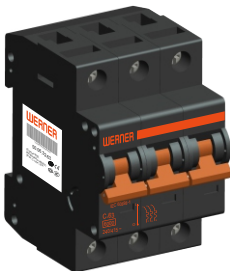
	In (A)	Curve B	Curve C	Curve D
	2	50.06.31.02	50.06.32.02	50.06.33.02
	4	50.06.31.04	50.06.32.04	50.06.33.04
	6	50.06.31.06	50.06.32.06	50.06.33.06
	10	50.06.31.10	50.06.32.10	50.06.33.10
	16	50.06.31.16	50.06.32.16	50.06.33.16
	20	50.06.31.20	50.06.32.20	50.06.33.20
	25	50.06.31.25	50.06.32.25	50.06.33.25
	32	50.06.31.32	50.06.32.32	50.06.33.32
	40	50.06.31.40	50.06.32.40	50.06.33.40
	50	50.06.31.50	50.06.32.50	50.06.33.50
63	50.06.31.63	50.06.32.63	50.06.33.63	

4 POLES

	In (A)	Curve B	Curve C	Curve D
	2	50.06.41.02	50.06.42.02	50.06.43.02
	4	50.06.41.04	50.06.42.04	50.06.43.04
	6	50.06.41.06	50.06.42.06	50.06.43.06
	10	50.06.41.10	50.06.42.10	50.06.43.10
	16	50.06.41.16	50.06.42.16	50.06.43.16
	20	50.06.41.20	50.06.42.20	50.06.43.20
	25	50.06.41.25	50.06.42.25	50.06.43.25
	32	50.06.41.32	50.06.42.32	50.06.43.32
	40	50.06.41.40	50.06.42.40	50.06.43.40
	50	50.06.41.50	50.06.42.50	50.06.43.50
63	50.06.41.63	50.06.42.63	50.06.43.63	

50 Series Miniature Circuit Breaker

WERNER

Model Number Selection

Breaking Capacity $I_{cn} = 10 \text{ kA}$

1 POLE

	In (A)	Curve B	Curve C	Curve D
	2	50.10.11.02	50.10.12.02	50.10.13.02
	4	50.10.11.04	50.10.12.04	50.10.13.04
	6	50.10.11.06	50.10.12.06	50.10.13.06
	10	50.10.11.10	50.10.12.10	50.10.13.10
	16	50.10.11.16	50.10.12.16	50.10.13.16
	20	50.10.11.20	50.10.12.20	50.10.13.20
	25	50.10.11.25	50.10.12.25	50.10.13.25
	32	50.10.11.32	50.10.12.32	50.10.13.32
	40	50.10.11.40	50.10.12.40	50.10.13.40
	50	50.10.11.50	50.10.12.50	50.10.13.50
63	50.10.11.63	50.10.12.63	50.10.13.63	

2 POLES

	In (A)	Curve B	Curve C	Curve D
	2	50.10.21.02	50.10.22.02	50.10.23.02
	4	50.10.21.04	50.10.22.04	50.10.23.04
	6	50.10.21.06	50.10.22.06	50.10.23.06
	10	50.10.21.10	50.10.22.10	50.10.23.10
	16	50.10.21.16	50.10.22.16	50.10.23.16
	20	50.10.21.20	50.10.22.20	50.10.23.20
	25	50.10.21.25	50.10.22.25	50.10.23.25
	32	50.10.21.32	50.10.22.32	50.10.23.32
	40	50.10.21.40	50.10.22.40	50.10.23.40
	50	50.10.21.50	50.10.22.50	50.10.23.50
63	50.10.21.63	50.10.22.63	50.10.23.63	

3 POLES

	In (A)	Curve B	Curve C	Curve D
	2	50.10.31.02	50.10.32.02	50.10.33.02
	4	50.10.31.04	50.10.32.04	50.10.33.04
	6	50.10.31.06	50.10.32.06	50.10.33.06
	10	50.10.31.10	50.10.32.10	50.10.33.10
	16	50.10.31.16	50.10.32.16	50.10.33.16
	20	50.10.31.20	50.10.32.20	50.10.33.20
	25	50.10.31.25	50.10.32.25	50.10.33.25
	32	50.10.31.32	50.10.32.32	50.10.33.32
	40	50.10.31.40	50.10.32.40	50.10.33.40
	50	50.10.31.50	50.10.32.50	50.10.33.50
63	50.10.31.63	50.10.32.63	50.10.33.63	

4 POLES

	In (A)	Curve B	Curve C	Curve D
	2	50.10.41.02	50.10.42.02	50.10.43.02
	4	50.10.41.04	50.10.42.04	50.10.43.04
	6	50.10.41.06	50.10.42.06	50.10.43.06
	10	50.10.41.10	50.10.42.10	50.10.43.10
	16	50.10.41.16	50.10.42.16	50.10.43.16
	20	50.10.41.20	50.10.42.20	50.10.43.20
	25	50.10.41.25	50.10.42.25	50.10.43.25
	32	50.10.41.32	50.10.42.32	50.10.43.32
	40	50.10.41.40	50.10.42.40	50.10.43.40
	50	50.10.41.50	50.10.42.50	50.10.43.50
63	50.10.41.63	50.10.42.63	50.10.43.63	

Auxiliary

Auxiliary Type	Auxiliary Model Number
Standard	50.00.01
Trip indicating	50.00.02
Under voltage release	50.00.03
Shunt release	50.00.04

Auxiliary contacts				Standard	Trip indicating	Under voltage release	Shunt release
		Model No.		50.00.01	50.00.02	50.00.03	50.00.04
Terminal capacity	Solid	Min./Max.	mm ²	1x 0.5/2.5	1x 0.5/2.5	1x 0.5/4	1x 1/25
	Stranded	Min./Max.	mm ²	2x 0.5/2.5	2x 0.5/2.5	2x 0.5/2.5	2x 1/4
Tightening torque			Nm	0.8	0.8	0.8	2.4
Degree of protection (terminals)				IP20	IP20	IP20	IP20

Weight

Weight		kg	0.045	0.045	0.155	0.155
--------	--	----	-------	-------	-------	-------

Auxiliary Contacts

Rated insulation voltage U _I				440	250	440	440
Rated operational current I _e	AC-12	230 V	A	–	2	–	–
	AC-13	230 V	A	–	2	–	–
		250 V	A	3	–	–	–
	AC-15	230 V	A	2	1	–	–
	DC-12	110 V	A	0.5	0.5	–	–
Minimum pulse duration			ms	–	–	–	>15
Minimum command time			ms	–	–	–	≤ 100 ms
Minimum operational voltage U _e		(AC/DC)	V/mA	5/10	5/10	–	–
Safe isolation between auxiliary and main contacts			VAC	440	440	–	–
Max. short-circuit protective device	Fuse	gG/gLA	A	6	6	Inherently	Inherently
Mechanical lifespan		Operations		≤ 7000	≤ 7000	≤ 12000	≤ 5000

Coil

Under voltage release	Drop-out voltage		xUs	–	–	0.7 - 0.35	–
	Inrush current (AC/DC)	Pick-up	A	–	–	3.6/44	–
Rated operational voltage U _e	50.00.04	VAC	–	–	–	–	12 – 110
	50.00.04	VAC	–	–	–	–	110 – 415
	50.00.04	VDC	–	–	–	–	24 – 60
	50.00.04	VDC	–	–	–	–	110 – 220
	50.00.04	VAC	–	–	–	115/230/400	–
Shunt release	Operating range		xUs	–	–	–	0.7-1.1
	Inrush current	Pick-up	A(AC)	–	–	–	25/12 ms
			A(DC)	–	–	–	15/3 ms

50 Series Miniature Circuit Breaker

WERNER

MCB Dimensions

1 Pole

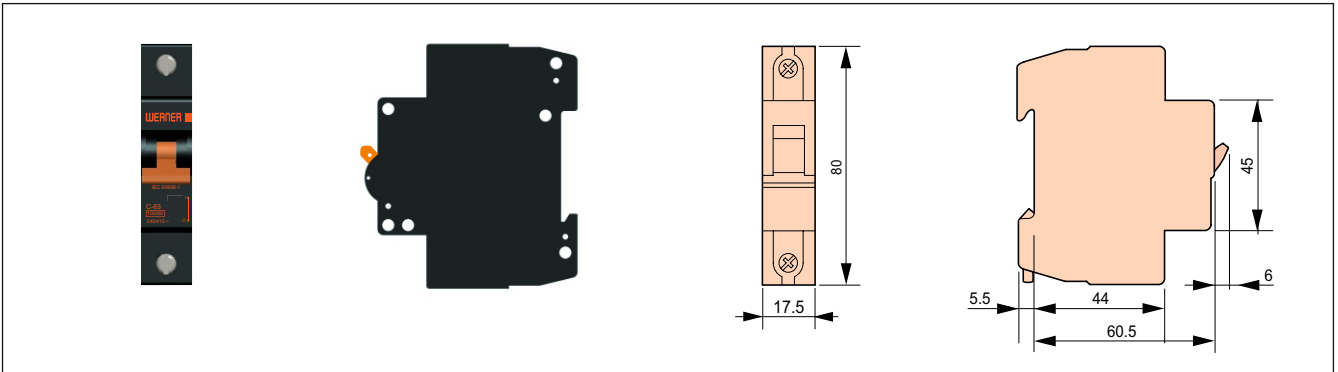

2 Poles

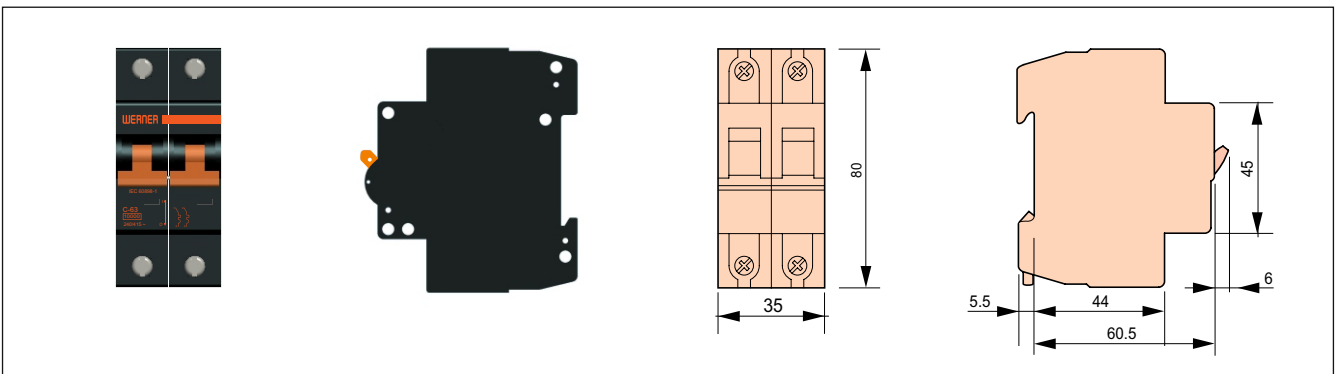

3 Poles

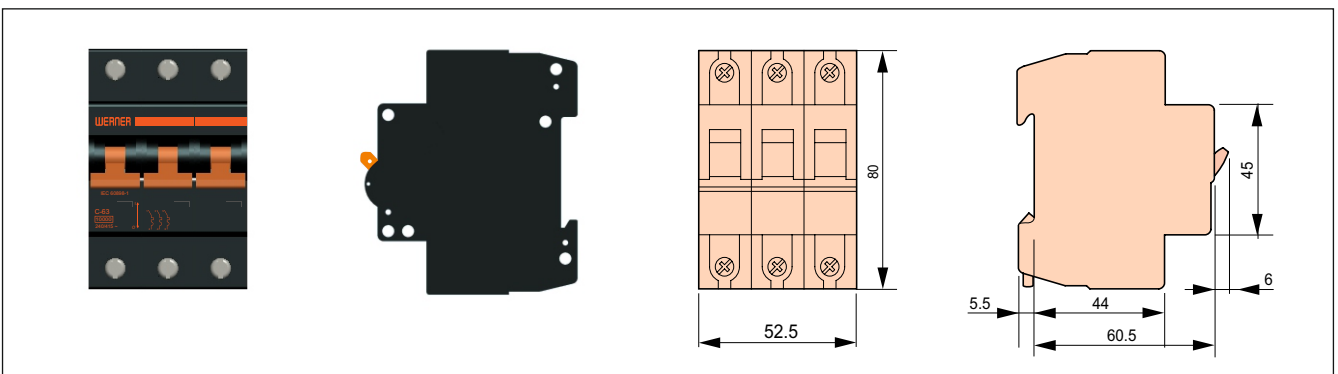

4 Poles

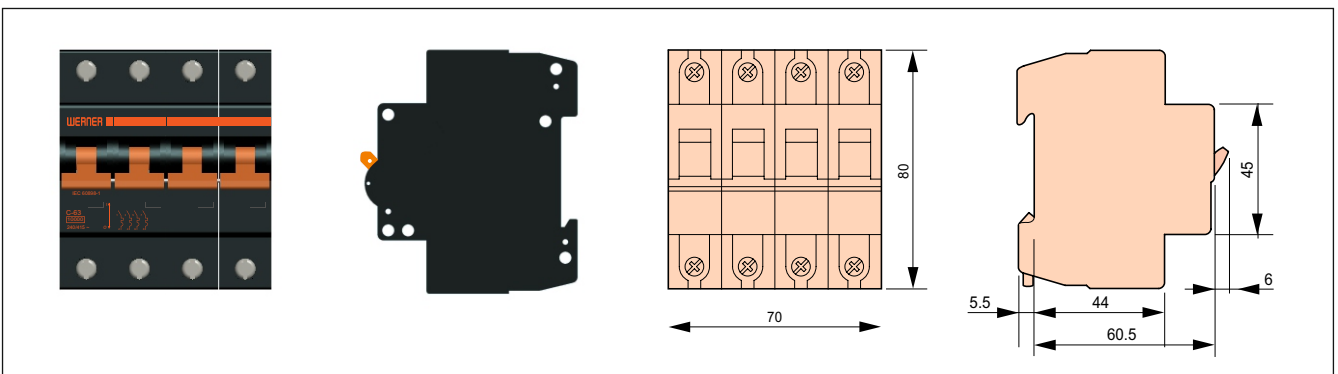

Auxiliary Dimensions

Standard Auxiliary Contact

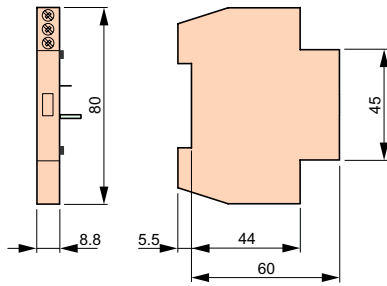

50.00.01

Trip Indicating Auxiliary Contact

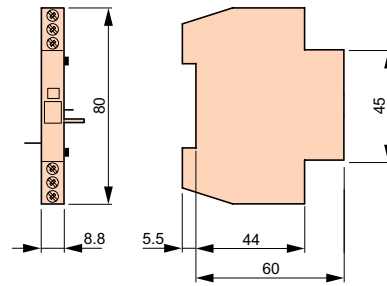

50.00.02

Under Voltage Release Auxiliary Contact

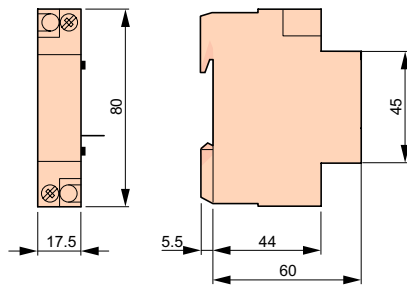

50.00.03

Shunt Release Auxiliary Contact

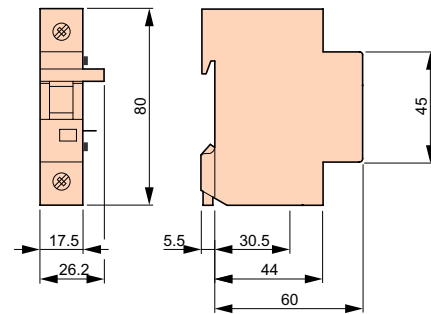

50.00.02

Terms And Conditions

Please read this catalog before purchasing any products. Please consult your *WERNER* representative for any clarifications or comments.

Application Considerations

WERNER shall not be responsible for conformity with any regulations, codes or standards that apply to use of the products. *WERNER* shall provide applicable third party certification documents identifying ratings and limitations of use that apply to the products in case of the customer's request.

Prevent use the products for an application involving risk to life or property. Be sure that the *WERNER*'s products are properly rated and installed for the overall system or equipment.

WERNER shall not be responsible for the user's programming of a programmable products.

Warranty

WERNER's warranty represents that the products are free from defects in materials and workmanship for a period of one year.

WERNER shall not be responsible for any special loss of profit, commercial loss, indirect or consequential damages relevant to products.

WERNER shall not be responsible for repair, warranty or any claims regarding the products unless *WERNER*'s Analysis confirm that the products were properly stored, installed, handled, maintained and not a result of accident, insufficient, abuse, misuse, natural disaster, improper installation excessive electrical supply, environmental conditions or abnormal mechanical.

Disclaimers

WERNER shall practice to change type/model numbers when published ratings or features are changed, however some specifications of the products may be changed without any notice.

When in doubt, please consult with your *WERNER* representative to confirm actual specifications of products.

WERNER shall change product specifications and accessories at any time based on improvements and other reasons.

The information in this catalog has been carefully checked and is believed to be accurate. However, *WERNER* take no responsibilities for clerical, typographical or proofreading errors.



WERNER

Inventing Innovation...

H.Q.

Werner Electric Private Limited

Plot No.: 166, Hebbal Industrial Area, Mysore - 570016, India.
Tel: +91 73539 47299, E-mail: info@wernerelektrik.com

Werner Malaysia Sdn Bhd,

45-2, Jalan Tiara 2B, Bandar Baru Klang,
41150, Klang, Selangor, Malaysia.

Tel: +60 13 533 3348, E-mail: info@wernerelektrik.com

Werner Elektrik Türkiye

Ayazağa Mah. Mimar Sinan Sok. Seba Office Boulevard.
D Blok. No.: 21D/45 Sariyer / İstanbul, Türkiye.

Tekefon: +90 539 588 41 01, E-posta: info@wernerelektrik.com

www.wernerelektrik.com